

Technical Reference



AWG5000 Series Arbitrary Waveform Generators Specifications and Performance Verification

077-0173-00

Warning

The servicing instructions are for use by qualified personnel only. To avoid personal injury, do not perform any servicing unless you are qualified to do so. Refer to all safety summaries prior to performing service.

www.tektronix.com

Copyright © Tektronix. All rights reserved. Licensed software products are owned by Tektronix or its subsidiaries or suppliers, and are protected by national copyright laws and international treaty provisions.

Tektronix products are covered by U.S. and foreign patents, issued and pending. Information in this publication supercedes that in all previously published material. Specifications and price change privileges reserved.

TEKTRONIX and TEK are registered trademarks of Tektronix, Inc.

Contacting Tektronix

Tektronix, Inc.
14200 SW Karl Braun Drive
P.O. Box 500
Beaverton, OR 97077
USA

For product information, sales, service, and technical support:

- In North America, call 1-800-833-9200.
- Worldwide, visit www.tektronix.com to find contacts in your area.

Warranty 2

Tektronix warrants that this product will be free from defects in materials and workmanship for a period of one (1) year from the date of shipment. If any such product proves defective during this warranty period, Tektronix, at its option, either will repair the defective product without charge for parts and labor, or will provide a replacement in exchange for the defective product. Batteries are excluded from this warranty. Parts, modules and replacement products used by Tektronix for warranty work may be new or reconditioned to like new performance. All replaced parts, modules and products become the property of Tektronix.

In order to obtain service under this warranty, Customer must notify Tektronix of the defect before the expiration of the warranty period and make suitable arrangements for the performance of service. Customer shall be responsible for packaging and shipping the defective product to the service center designated by Tektronix, shipping charges prepaid, and with a copy of customer proof of purchase. Tektronix shall pay for the return of the product to Customer if the shipment is to a location within the country in which the Tektronix service center is located. Customer shall be responsible for paying all shipping charges, duties, taxes, and any other charges for products returned to any other locations

This warranty shall not apply to any defect, failure or damage caused by improper use or improper or inadequate maintenance and care. Tektronix shall not be obligated to furnish service under this warranty a) to repair damage resulting from attempts by personnel other than Tektronix representatives to install, repair or service the product; b) to repair damage resulting from improper use or connection to incompatible equipment; c) to repair any damage or malfunction caused by the use of non-Tektronix supplies; or d) to service a product that has been modified or integrated with other products when the effect of such modification or integration increases the time or difficulty of servicing the product.

THIS WARRANTY IS GIVEN BY TEKTRONIX WITH RESPECT TO THE PRODUCT IN LIEU OF ANY OTHER WARRANTIES, EXPRESS OR IMPLIED. TEKTRONIX AND ITS VENDORS DISCLAIM ANY IMPLIED WARRANTIES OF MERCHANTABILITY OR FITNESS FOR A PARTICULAR PURPOSE. TEKTRONIX' RESPONSIBILITY TO REPAIR OR REPLACE DEFECTIVE PRODUCTS IS THE SOLE AND EXCLUSIVE REMEDY PROVIDED TO THE CUSTOMER FOR BREACH OF THIS WARRANTY. TEKTRONIX AND ITS VENDORS WILL NOT BE LIABLE FOR ANY INDIRECT, SPECIAL, INCIDENTAL, OR CONSEQUENTIAL DAMAGES IRRESPECTIVE OF WHETHER TEKTRONIX OR THE VENDOR HAS ADVANCE NOTICE OF THE POSSIBILITY OF SUCH DAMAGES

Table of Contents

General Safety Summary	v
Environmental Considerations	vii
Preface	ix
Related Documents	ix

Specifications

Performance Conditions	1-1
Electrical Specifications	1-2
Mechanical (Physical) Characteristics	1-11
Environmental Characteristics	1-12
Certifications and Compliances	1-13

Performance Verification

Performance Verification Procedures	2-1
Brief Procedures	2-3
Diagnostics	2-3
Self Calibration	2-4
Functional Test	2-5
Performance Tests	2-11
Prerequisites	2-11
Equipment Required	2-11
Test Record	2-13
10 MHz Reference Frequency Accuracy	2-22
Analog Offset Accuracy	2-23
Analog Amplitude Accuracy	2-26
Analog Harmonic Distortion	2-28
Analog Non-Harmonic Spurious Signal	2-30
Analog Phase Noise	2-32
Marker High and Low Level Accuracy	2-35
Marker Output Delay Accuracy	2-38
DC Output Voltage Accuracy	2-40

List of Figures

Figure 2-1: Diagnostics dialog box	2-4
Figure 2-2: Calibration dialog box	2-5
Figure 2-3: Equipment connections for checking the analog and marker outputs	2-6
Figure 2-4: Output waveform from the Analog, Mkr1, and Mkr 2 connectors	2-7
Figure 2-5: Equipment connection for checking the digital data outputs	2-8
Figure 2-6: Output waveform from the Digital Data Out connector	2-10
Figure 2-7: Equipment connection for verifying the 10 MHz reference frequency accuracy	2-22
Figure 2-8: Equipment connection for measuring the terminator resistance	2-23
Figure 2-9: Equipment connection for verifying the analog offset accuracy	2-24
Figure 2-10: Equipment connections for verifying the analog harmonic distortion	2-28
Figure 2-11: Equipment connections for verifying the non-harmonic spurious signal	2-30
Figure 2-12: Equipment connections for verifying the analog phase noise	2-32
Figure 2-13: Example of the analog phase noise measurement	2-34
Figure 2-14: Equipment connection for verifying the marker high and low level accuracy	2-35
Figure 2-15: Equipment connections for verifying the marker output delay accuracy	2-38
Figure 2-16: Equipment connection for verifying the DC output voltage accuracy	2-40

List of Tables

Table 1-1: Run mode	1-2
Table 1-2: Arbitrary waveform	1-2
Table 1-3: Clock generator	1-3
Table 1-4: Trigger generator	1-3
Table 1-5: Inter-channel skew control	1-3
Table 1-6: Phase and delay control for analog output	1-4
Table 1-7: Analog output	1-4
Table 1-8: Marker output	1-6
Table 1-9: Digital data output (option 03 only)	1-7
Table 1-10: Trigger and gate input	1-7
Table 1-11: Event input	1-8
Table 1-12: Reference clock input	1-8
Table 1-13: External clock input	1-9
Table 1-14: Add input	1-9
Table 1-15: DC output	1-9
Table 1-16: Oscillator output	1-10
Table 1-17: 10 MHz reference output	1-10
Table 1-18: TekLink port	1-10
Table 1-19: CPU module and peripheral devices	1-10
Table 1-20: Display	1-11
Table 1-21: Power supply	1-11
Table 1-22: Mechanical characteristics	1-11
Table 1-23: Environmental characteristics	1-12
Table 1-24: Certifications and compliances	1-13
Table 2-1: Equipment required	2-11
Table 2-2: Test waveforms	2-12
Table 2-3: Analog offset accuracy	2-25
Table 2-4: Analog amplitude accuracy	2-27
Table 2-5: Analog harmonic distortion	2-29
Table 2-6: Analog non-harmonic spurious signal	2-31
Table 2-7: Analog phase noise	2-33
Table 2-8: Marker High and Low level accuracy	2-36
Table 2-9: DC output voltage accuracy	2-41

General Safety Summary

Review the following safety precautions to avoid injury and prevent damage to this product or any products connected to it. To avoid potential hazards, use this product only as specified.

Only qualified personnel should perform service procedures.

To Avoid Fire or Personal Injury

Use Proper Power Cord. Use only the power cord specified for this product and certified for the country of use.

Ground the Product. This product is grounded through the grounding conductor of the power cord. To avoid electric shock, the grounding conductor must be connected to earth ground. Before making connections to the input or output terminals of the product, ensure that the product is properly grounded.

Observe All Terminal Ratings. To avoid fire or shock hazard, observe all ratings and markings on the product. Consult the product manual for further ratings information before making connections to the product.

Do Not Operate Without Covers. Do not operate this product with covers or panels removed.

Avoid Exposed Circuitry. Do not touch exposed connections and components when power is present.

Do Not Operate With Suspected Failures. If you suspect there is damage to this product, have it inspected by qualified service personnel.

Do Not Operate in Wet/Damp Conditions.

Do Not Operate in an Explosive Atmosphere.

Keep Product Surfaces Clean and Dry.

Provide Proper Ventilation. Refer to the manual's installation instructions for details on installing the product so it has proper ventilation.

No Power Switch. Power supply cord is considered the disconnecting device, disconnect the main power by means of the power cord.

Symbols and Terms

Terms in this Manual. These terms may appear in this manual:



WARNING. *Warning statements identify conditions or practices that could result in injury or loss of life.*



CAUTION. *Caution statements identify conditions or practices that could result in damage to this product or other property.*

Terms on the Product. These terms may appear on the product:

DANGER indicates an injury hazard immediately accessible as you read the marking.

WARNING indicates an injury hazard not immediately accessible as you read the marking.

CAUTION indicates a hazard to property including the product.

Symbols on the Product. The following symbols may appear on the product:



Environmental Considerations

This section provides information about the environmental impact of the product.

Product End-of-Life Handling

Observe the following guidelines when recycling an instrument or component:

Equipment Recycling. Production of this equipment required the extraction and use of natural resources. The equipment may contain substances that could be harmful to the environment or human health if improperly handled at the product's end of life. In order to avoid release of such substances into the environment and to reduce the use of natural resources, we encourage you to recycle this product in an appropriate system that will ensure that most of the materials are reused or recycled appropriately.



The symbol shown to the left indicates that this product complies with the European Union's requirements according to Directive 2002/96/EC on waste electrical and electronic equipment (WEEE). For information about recycling options, check the Support/Service section of the Tektronix Web site (www.tektronix.com).

Mercury Notification. This product uses an LCD backlight lamp that contains mercury. Disposal may be regulated due to environmental considerations. Please contact your local authorities or, within the United States, the Electronics Industries Alliance (www.eiae.org) for disposal or recycling information.

Restriction of Hazardous Substances

This product has been classified as Monitoring and Control equipment, and is outside the scope of the 2002/95/EC RoHS Directive. This product is known to contain lead, cadmium, mercury, and hexavalent chromium.

Preface

This manual contains specifications and performance verification procedures for the AWG5000 Series Arbitrary Waveform Generators.

Related Documents

The following user documents are also available for this product:

- *AWG5000 Series Arbitrary Waveform Generators Quick Start User Manual.*
This document describes the functions and use of the instrument.
- *AWG5000 Series Arbitrary Waveform Generators Service Manual.*
This is an optional accessory that provides module-level service information.



Specifications

Specifications

This section contains the specifications for the AWG5012, AWG5014, AWG5002, and AWG5004 Arbitrary Waveform Generators.

All specifications are guaranteed unless noted as “typical”. Typical specifications are provided for your convenience but are not guaranteed. Specifications that are marked with the ✓ symbol are checked in the Performance Verification section of this manual.

Performance Conditions

To meet specifications, following conditions must be met:

- The instrument must have been calibrated/adjusted at an ambient temperature between +20 °C and +30 °C.
- The instrument must have been operating continuously for 20 minutes within the operating temperature range specified.
- The instrument must be in an environment where the temperature, altitude, humidity, and vibration conditions are within the operating limits described in these specifications.

Electrical Specifications

Table 1-1: Run mode

Characteristics	Description
Continuous mode	An arbitrary waveform is output continuously.
Triggered mode	An arbitrary waveform is output only once when a trigger signal is applied. After the waveform is output, the instrument waits for the next trigger signal.
Gated mode	An arbitrary waveform is output only when a gate signal is asserted. The waveform output is repeated while the gate signal stays asserted. When the gate signal is deasserted, the waveform output stops immediately.
Sequence mode	A sequence of arbitrary waveforms are output.

Table 1-2: Arbitrary waveform

Characteristics	Description
Waveform length	
Without Option 01	1 to 16,200,000 points
With Option 01	1 to 32,400,000 points
Waveform granularity	1 point
DAC resolution	14 bits
Number of waveforms	1 to 32,000 waveforms
Sequence length	1 to 4,000 steps
Sequence controls	Repeat count, Wait-for-Trigger, Go-to-N, and Jump are available.
Repeat count	1 to 65,536 or infinite (all channels operate the same sequence)
Jump timing	Synchronous or Asynchronous selectable

Table 1-3: Clock generator

Characteristics	Description
Sampling rate control	
Range	
AWG5012 and AWG5014	10.0000 MS/s to 1.2000 GS/s
AWG5002 and AWG5004	10.0000 MS/s to 600.000 MS/s
Resolution	8 digits
✓ Internal clock frequency accuracy	Within \pm (1 ppm +aging)
Internal clock frequency accuracy, typical	Aging: within \pm 1 ppm/year
Reference oscillator accuracy	Within \pm (1 ppm +aging)
Reference oscillator accuracy, typical	Aging: within \pm 1 ppm/year

Table 1-4: Trigger generator

Characteristics	Description
Trigger rate	
Range	1.0 μ s to 10.0 s
Resolution	3 digits and 0.1 μ s minimum
Accuracy	Same as the reference oscillator

Table 1-5: Inter-channel skew control

Characteristics	Description
Skew control	
Range	-5 ns to +5 ns
Resolution	5 ps
Skew accuracy	\pm (10% of setting +150 ps)

Table 1-6: Phase and delay control for analog output

Characteristics	Description
Phase control	
Range	-180 ° to +180 ° of waveform
Resolution	0.1 ° of waveform
Time control	
Range	-1/2 period to +1/2 period of waveform
Resolution	1 ps
Point control	
Range	-50% to +50% of waveform
Resolution	0.001 points

Table 1-7: Analog output

Characteristics	Description
Connector type	BNC at front panel
Type of output	(+) and (-) complementary output
Output impedance	50 Ω
Amplitude controls	
Range	
Normal mode	20 mV to 4.5 V peak-peak
Direct D/A mode	20 mV to 0.6 V peak-peak
Resolution	1 mV
Offset controls	
Range	
Normal mode	-2.25 V to +2.25 V
Direct D/A mode	N/A
Resolution	1 mV
✓ Amplitude accuracy	DC accuracy: within ± (2% of amplitude + 2 mV) at offset=0V
✓ Offset accuracy	DC accuracy: within ± (2% of offset + 15 mV) at minimum amplitude
Bandwidth, typical	
Normal mode	250 MHz (at -3 dB), when amplitude= 2.0 Vp-p, offset=0 V
Direct D/A mode	370 MHz (at -3 dB), when amplitude=0.6 Vp-p

Table 1-7: Analog output (Cont.)

Characteristics	Description
Rise/fall time, typical	
Normal mode	1.4 ns (10% to 90%), when amplitude= 2.0 Vp-p, offset=0 V
Direct D/A mode	0.95 ns (10% to 90%), when amplitude=0.6 Vp-p
Overshoot, typical	< 10%, when amplitude=2.0 Vp-p
Ringing, typical	
Normal mode	80 mV, when amplitude= 2.0 Vp-p, filter= through 750 mV, when amplitude= 4.5 Vp-p, filter= through
Direct D/A mode	60 mV, when amplitude=0.6 Vp-p
Low pass filter	
Normal mode	20 MHz, 100 MHz, through (Bessel type)
Direct D/A mode	N/A
Delay from marker, typical	Direct output delay +19.0 ns: low pass=20 MHz Direct output delay +5.3 ns: low pass=100 MHz Direct output delay +1.5 ns: low pass=through -1.5 ns to +0.4 ns: direct D/A mode (when amplitude=0.6 Vp-p, offset=0 V)
Skew between (+) and (-) outputs, typical	< 200 ps (direct D/A mode)
ON/OFF control	Output relay is available for each channel. A control is common to the complementary output.
✓ Harmonic distortion	Measured with 32 points sine waveform. This specification is defined up to 5th harmonics.
AWG501x Normal mode	< -40 dBc, when amplitude=2.0 Vp-p, offset=0 V, clock=1.2 GS/s, signal=37.5 MHz
AWG501x Direct D/A mode	< -49 dBc, when amplitude=0.6 Vp-p, clock=1.2 GS/s, signal=37.5 MHz
AWG500x Normal mode	< -46 dBc, when amplitude=2.0 Vp-p, offset=0 V, clock=600 MS/s, signal=18.75 MHz
AWG500x Direct D/A mode	< -55 dBc, when amplitude=0.6 Vp-p, clock=600 MS/s, signal=18.75 MHz
✓ Non harmonic spurious	Amplitude=2.0 Vp-p, offset=0 V, measured with 32 points sine waveform.
AWG5012 and AWG5014	< -60 dBc, DC to 600 MHz, when clock=1.2 GS/s, signal=37.5 MHz
AWG5002 and AWG5004	< -60 dBc, DC to 300 MHz, when clock=600 MS/s, signal=18.75 MHz
SFDR, typical	
AWG501x	50 dBc, when clock=1.2 GS/s, signal=37.5 MHz (normal output mode, amplitude=2.0 Vp-p, offset=0 V, measured with 32 points sine waveform.)
AWG501x and AWG500x	56 dBc, when clock=600 MS/s, signal=18.75 MHz (normal output mode, amplitude=2.0 Vp-p, offset=0 V, measured with 32 points sine waveform.)

Table 1-7: Analog output (Cont.)

Characteristics	Description
Normal mode Amplitude = 1.0 Vp-p	-60 dBc, when signal=10 MHz (clock=600 MS/s, offset =0 V, measured with 60 points/cycle sine waveform, DC to 300 MHz.) -80 dBc, when signal=1 MHz (clock=600 MS/s, offset =0 V, measured with 600 points/cycle sine waveform, DC to 300 MHz.)
Direct D/A mode Amplitude = 0.6 Vp-p	-64 dBc, when signal=10 MHz (clock=600 MS/s, offset =0 V, measured with 60 points/cycle sine waveform, DC to 300 MHz.) -80 dBc, when signal=1 MHz (clock=600 MS/s, offset =0 V, measured with 600 points/cycle sine waveform, DC to 300 MHz.)
✓ Phase noise	Amplitude=2.0 Vp-p, offset=0 V, measured with 32 points sine waveform.
AWG5012 and AWG5014	< -85 dBc/Hz at 10 kHz offset, when clock=1.2 GS/s, signal=37.5 MHz
AWG5002 and AWG5004	< -85 dBc/Hz at 10 kHz offset, when clock=600 MS/s, signal=18.75 MHz

Table 1-8: Marker output

Characteristics	Description
Connector type	BNC at front panel
Number of outputs	Marker 1 and Marker 2 are available for each channel.
Type of output	Single-ended output
Output impedance	50 Ω
Level controls	
Voltage range	-1.0 V to +2.7 V into 50 Ω
Amplitude	0.1 Vp-p minimum
Resolution	0.01 V
✓ Level accuracy	\pm (10% of setting + 120 mV) into 50 Ω
Output current	\pm 54 mA maximum
Variable delay control	Available for Marker 1 and Marker 2
Range	0 to 1000 ps
Resolution	50 ps
✓ Variable delay accuracy	\pm (5% of setting + 250 ps)
Rise/fall time, typical	300 ps (20% to 80% of swing), when Hi= 1.0 V, Low=0V
Random jitter on clock pattern, typical	5 ps rms (by 0101... clock pattern), when Hi= 1.0 V, Low=0V
Total jitter on random pattern, typical	150 ps p-p (by PN15 pattern pattern, when Hi= 1.0 V, Low=0V)

Table 1-9: Digital data output (option 03 only)

Characteristics	Description
Connector type	SMB at front panel
Number of outputs	28 (14-bit output on channel 1 and 2)
Output impedance	50 Ω
Level controls	
Voltage range	-1.0 V to +2.7 V into 50 Ω
Amplitude	0.1 Vp-p minimum
Resolution	0.01 V
Level accuracy, typical	\pm (10% of setting + 120 mV) into 50 Ω
Output current	\pm 54 mA maximum
Rise/fall time, typical	300 ps (20% to 80%, when Hi= 1.0 V, Low=0V)
Delay from maker, typical	-41 ns to -82 ns, when Hi= 1.0 V, Low=0V
ON/OFF control	A common ON/OFF control is available for 14 bits output
Skew between outputs, typical	< 400 ps between 14-bit outputs

Table 1-10: Trigger and gate input

Characteristics	Description
Connector type	BNC at front panel
Input impedance	1 k Ω or 50 Ω selectable
Polarity	Positive or negative selectable
Input voltage range	
When 1 k Ω selected	-10 V to 10 V
When 50 Ω selected	< 5 V rms
Threshold control	
Level	-5.0 V to 5.0 V
Resolution	0.1 V
Accuracy, typical	\pm (5% of setting + 0.1 V)
Input voltage swing	0.5 Vp-p minimum
Minimum pulse width	
Trigger mode	20 ns
Gate mode	1024 X sampling period + 10 ns
Trigger delay to analog output, typical	48 X sampling period + 500 ns
Trigger hold off time, typical	160 X sampling period - 200 ns

Table 1-10: Trigger and gate input (Cont.)

Characteristics	Description
Gate delay to analog output, typical	240 X sampling period + 500 ns
Trigger jitter, typical	2.0 ns to 4.5 ns

Table 1-11: Event input

Characteristics	Description
Connector type	BNC at front panel
Input impedance	1 k Ω or 50 Ω selectable
Polarity	Positive or negative selectable
Input voltage range	
When 1 k Ω selected	-10 V to 10 V
When 50 Ω selected	< 5 Vrms
Threshold control	
Level	-5.0 V to 5.0 V
Resolution	0.1 V
Accuracy, typical	\pm (5% of setting + 0.1 V)
Input voltage swing	0.5 Vp-p minimum
Minimum pulse width	20 ns
Delay to analog output, typical	200 X sampling period + 500 ns
Hold off time, typical	260 X sampling period + 300 ns

Table 1-12: Reference clock input

Characteristics	Description
Connector type	BNC at front panel
Input impedance	50 Ω (AC coupled)
Input voltage swing	0.2 Vp-p to 3 Vp-p
Fixed mode input frequency	10 MHz, 20 MHz, and 100 MHz within \pm 0.5%
Variable mode input frequency range	5 MHz to 600 MHz Acceptable frequency drift while running is \pm 0.5%
Variable mode multiplier rate	
AWG5012 and AWG5014	1 to 240
AWG5002 and AWG5004	1 to 120

Table 1-13: External clock input

Characteristics	Description
Connector type	BNC at rear panel
Input impedance	50 Ω (AC coupled)
Frequency range	600 MHz to 1200 MHz
Input voltage swing	0.2 V to 0.8 Vp-p
Divider	
AWG5012 and AWG5014	1/1, 1/2, 1/4, 1/8, ... ,1/32
AWG5002 and AWG5004	1/2, 1/4, 1/8, ... ,1/32

Table 1-14: Add input

Characteristics	Description
Connector type	BNC at rear panel, for each channel
Input impedance	50 Ω (DC coupled)
DC gain, typical	1
Bandwidth, typical	DC to 100 MHz, at -3 dB, when amplitude is 1 Vp-p
Input voltage range	± 1.0 V
Maximum input voltage	± 5.0 V

Table 1-15: DC output

Characteristics	Description
Connector type	2 x 4 pin header, 2.54 mm pitch (female)
Number of outputs	4
Output voltage control	
Range	-3.0 V to +5.0 V
Resolution	10 mV
Control	Independent for each output
✓ Output voltage accuracy	\pm (3% of setting + 80 mV) into Hi-Z load
Output current	± 100 mA maximum
Output impedance, typical	1 Ω

Table 1-16: Oscillator output

Characteristics	Description
Connector type	BNC at rear panel
Output impedance	50 Ω (AC coupled)
Output frequency range	600 MHz to 1200 MHz
Output voltage swing, typical	0.4 Vp-p into 50 Ω

Table 1-17: 10 MHz reference output

Characteristics	Description
Connector type	BNC at rear panel
Output impedance	50 Ω (AC coupled)
Amplitude, typical	1.2 Vp-p into 50 Ω 2.4 Vp-p into 1 M Ω

Table 1-18: TekLink port

Characteristics	Description
Connector type	40 pin
Signals	LVDS, 3.3 V CMOS and Ethernet
Function	Future capability.

Table 1-19: CPU module and peripheral devices

Characteristics	Description
CPU	Celeron D processor
Memory	512 MB DDR2-SDRAM
Hard disk drive	More than 80 GB
Optical disk drive	CD-RW/DVD drive
USB 2.0 port	6 (2 x front, 4 x rear)
LAN port	1000/100/10 BASE-T
Video output port	D-sub, 15 pin
GPIO port	IEEE 488.2 standard interface, 24 pin
Keyboard port	PS-2 compatible, mini-DIN, 6-pin
Mouse port	PS-2 compatible, mini-DIN, 6-pin
Serial port	RS-232C, D-sub, 9 pin

Table 1-19: CPU module and peripheral devices (Cont.)

Characteristics	Description
Parallel port	D-sub, 25 pin
Audio connectors	Line output, line input, mic input, stereo jack
Real time clock	Lifetime > 3 years (CR2032: Li 3 V 220 mAh)

Table 1-20: Display

Characteristics	Description
Size	210 mm X 158 mm
Resolution	1024 X 768 pixels
Touch screen	Built-in touch screen

Table 1-21: Power supply

Characteristics	Description
Source voltage and frequency	
Rating voltage	100 VAC to 240 VAC
Voltage range	90 VAC to 250 VAC
Frequency range	47 Hz to 63 Hz
Power consumption	560 W
Surge current	30 A peak (25 °C) for ≤ 5 line cycles, after product has been turned off for at least 30 s.

Mechanical (Physical) Characteristics

Table 1-22: Mechanical characteristics

Characteristics	Description
Net weight	
Without package	Approximately 19.5 kg (43.0 lb)
With package	Approximately 28.5 kg (62.8 lb)
Dimensions	
Height	245 mm (9.6 in)
Width	465 mm (18.3 in)
Length	500 mm (19.7 in)

Environmental Characteristics

Table 1-23: Environmental characteristics

Characteristics	Description
Temperature	
Operating	+10 °C to +40 °C
Non-operating	-20 °C to +60 °C
Relative humidity	
Operating	5% to 80% (no condensation) Maximum wet-bulb temperature 29 °C
Non-operating	5% to 90% (no condensation) Maximum wet-bulb temperature 29 °C
Altitude	
Operating	Up to 3,000 m (approximately 10,000 feet) Maximum operating temperature decreases 1 °C each 300 m above 1.5 km
Non-operating	Up to 12,000 m (approximately 40,000 feet)
Dynamics	
Vibration	
Operating	2.65 m/s ² rms (0.27 Grms), 5 Hz to 500 Hz, 10 min, three axes
Non-operating	22.3 m/s ² rms (2.28 Grms), 5 Hz to 500 Hz, 10 min, three axes
Shock	
Non-operating	294 m/s ² (30 G), half-sine, 11 ms duration
Installation requirements	
Power dissipation	560 W (600 VA maximum)
Surge current	30 A peak (25 °C) for ≤ 5 line cycles, after product has been turned off for at least 30 s.
Cooling clearance	
Top and bottom clearance	2 cm (0.8 in)
Side clearance	15 cm (5.9 in)
Rear clearance	7.5 cm (3.0 in)

Certifications and Compliances

Table 1-24: Certifications and compliances

Category	Standards or description
EC Declaration of Conformity - EMC	<p>Meets the intent of Directive 89.336/EEC for Electromagnetic Compatibility. Compliance was demonstrated to the following specifications as listed in the Official Journal of the European Communities:</p> <p>EN61326. EMC requirement for Class A electrical equipment for measurement, control and laboratory use. ^{1,2}</p> <p>IEC 61000-4-2 Electrostatic discharge Immunity (Performance Criterion B)</p> <p>IEC 61000-4-3 RF electromagnetic field Immunity (Performance Criterion A)</p> <p>IEC 61000-4-4 Electrical fast transient / burst Immunity (Performance Criterion B)</p> <p>IEC 61000-4-5 Power line surge Immunity (Performance Criterion B)</p> <p>IEC 61000-4-6 Conducted RF Immunity (Performance Criterion A)</p> <p>IEC 61000-4-11 Voltage dips and Interruptions (Performance Criterion B)</p> <p>EN 61000-3-2. AC power line harmonic emissions</p> <p>EN 61000-3-3. Voltage changes, fluctuation, and flicker</p> <p>¹ Emissions which exceed the levels required by this standard may occur when this equipment is connected to a test object.</p> <p>² To ensure compliance to the standards listed above, attach only high quality shielded cables to this instrument. High quality shielded cables typically are braid and foil types that have low impedance connection to shielded connectors at both ends.</p>
Australia/New Zealand Declaration of Conformity - EMC	<p>Complies with EMC provision of Radio Communications Act per the following standard(s):</p> <p>AS/NZS 2064.1/2, Industrial, Scientific, and Medical Equipment: 1992</p>
EC Declaration of Conformity - Low Voltage	<p>Compliance was demonstrated to the following specification as listed in the Official Journal of the European Communities:</p> <p>Low Voltage Directive 73/23/EEC, amended by 93/68/EEC.</p> <p>EN 61010-1:2001 Safety requirements for electrical equipment for measurement, control, and laboratory use.</p>
U.S. Nationally Recognized Testing Laboratory Listing	<p>UL61010-01:2004, 2nd Edition Standard for electrical measuring and test equipment.</p>
Canadian Certification	<p>CAN/CSA C22.2 No. 61010-1:2004 Safety requirement for electrical equipment for measurement, control, and laboratory use. Part 1.</p>
Additional Compliance	<p>IEC 61010-1:2001 Safety requirements for electrical equipment for measurement, control, and laboratory use.</p>

Table 1-24: Certifications and compliances (Cont.)

Category	Standards or description
Safety	<p>Complies with the following safety standards/regulations:</p> <p>UL 61010-1 Standard for Electrical Measuring and Test Equipment.</p> <p>CAN/CSA C22.2 No.61010-1-04 Safety Requirements for Electrical Equipment for Measurement, Control, and Laboratory Use.</p> <p>EN 61010-1:2001 Safety Requirements for Electrical Equipment for Measurement, Control, and Laboratory Use.</p>
Installation (Overvoltage) Category	<p>Terminals on this product may have different installation (overvoltage) category designations. The installation categories are:</p> <p>CAT III Distribution-level mains (usually permanently connected). Equipment at this level is typically in a fixed industrial location.</p> <p>CAT II Local-level mains (wall sockets). Equipment at this level includes appliances, portable tools, and similar products. Equipment is usually cord-connected.</p> <p>CAT I Secondary (signal level) or battery operated circuits of electronic equipment.</p>
Overvoltage Category	Overvoltage Category II (as defined in IEC 61010-1)
Pollution Degree Descriptions	<p>A measure of the contaminates that could occur in the environment around and within a product. Typically the internal environment inside a product is considered to be the same as the external. Products should be used only in the environment for which they are rated.</p> <p>Pollution Degree 1 No pollution or only dry, nonconductive pollution occurs. Products in this category are generally encapsulated, hermetically sealed, or located in clean rooms.</p> <p>Pollution Degree 2 Normally only dry, nonconductive pollution occurs. Occasionally a temporary conductivity that is caused by condensation must be expected. This location is a typical office/home environment. Temporary condensation occurs only when the product is out of service.</p> <p>Pollution Degree 3 Conductive pollution, or dry, nonconductive pollution that becomes conductive due to condensation. These are sheltered locations where neither temperature nor humidity is controlled. The area is protected from direct sunshine, rain, or direct wind.</p>
Pollution Degree	Pollution Degree 2 (as defined in IEC 61010-1). Note: Rated for indoor use only.
Equipment Type	Test and measuring equipment
Safety Class	Class I - grounded product



Performance Verification

Performance Verification Procedures

Two types of performance verification procedures can be performed on the instrument: *Brief Procedures* and *Performance Tests*. You may not need to perform all of these procedures, depending on what you want to accomplish.

- To rapidly confirm that the instrument functions and was adjusted properly, perform *Diagnostics* and *Self Calibration* beginning on page 2-3.

Advantages: These procedures are quick to do and require no external equipment or signal sources. These procedures perform extensive functional and accuracy testing to provide high confidence that the instrument will perform properly.

- To further check functionality, first perform *Diagnostics* and *Self Calibration*, and then perform *Functional Test* beginning on page 2-5.

Advantages: The procedure requires minimal additional time to perform, and requires minimal equipment. The procedure can be used when the instrument is first received.

- If more extensive confirmation of performance is desired, complete the self tests and functional test, and then do the *Performance Tests* beginning on page 2-11.

Advantages: These procedures add direct checking of warranted specifications. These procedures require suitable test equipment and more time to execute (refer to *Equipment Required* on page 2-11).

If you are not familiar with operating this instrument, refer to the online help or the user information supplied with the instrument.

Brief Procedures

There are three procedures in this section that provide a quick way to confirm basic functionality and proper adjustment:

- *Diagnostics*
- *Self Calibration*
- *Functional Test*

Diagnostics

The following steps run the internal routines that confirm basic functionality and proper adjustment.

Equipment	None
Prerequisites	None

1. Disconnect all the cables from the output channels.
2. Select **System > Diagnostics** to open the **Diagnostics** dialog box. See Figure 2-1 on page 2-4.

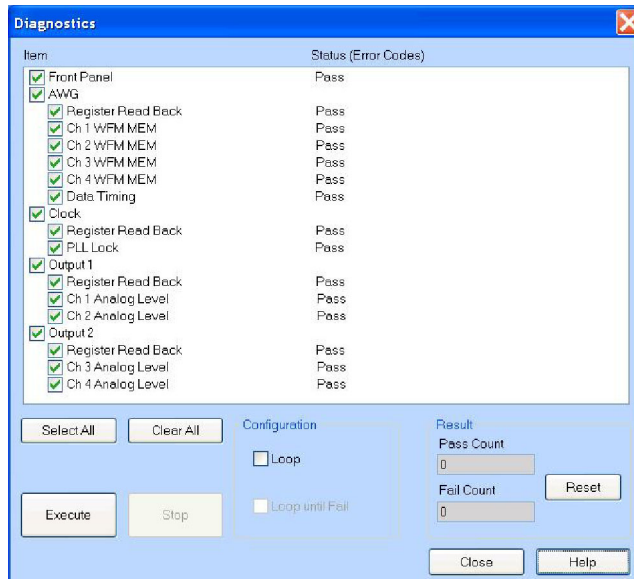

Figure 2-1: Diagnostics dialog box

3. In the Diagnostics dialog box, confirm that all the check boxes are selected. If they are not all selected, click the **Select All** button.
4. Click the **Execute** button to execute the diagnostics.

The internal diagnostics perform an exhaustive verification of proper instrument function. This verification may take several minutes. When the verification is completed, the resulting status will appear in the dialog box.
5. Verify that **Pass** appears as Status in the dialog box when the diagnostics complete.
6. Click the **Close** button to close the dialog box.

Self Calibration

Equipment	None
Prerequisites	Power on the instrument and allow a 20 minute warm-up before doing this procedure.

1. Select **System > Calibration** to open the **Calibration** dialog box. See Figure 2-2.

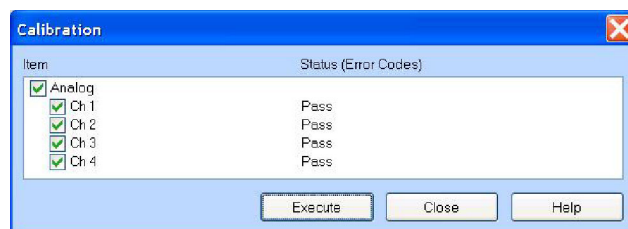

Figure 2-2: Calibration dialog box

2. Click the **Execute** button to start the routine.
3. Verify that **Pass** appears in the status column for all items when the calibration completes.
4. Click the **Close** button to close the dialog box.

Functional Test

The purpose of the procedure is to confirm that the instrument functions properly. The equipment required is three 50 Ω BNC cables, an oscilloscope, and a 50 Ω SMB-BNC cable (Option 03 only).

Checking the Analog and Marker Outputs

Equipment required	Oscilloscope (TDS5054B or equivalent) Three 50 Ω BNC cables
Prerequisites	None

1. Press the **All Outputs On/Off** button on the AWG5000 to turn off all the outputs.
2. Use a 50 Ω BNC cable to connect the Channel 1 Analog connector on the AWG5000 to the CH1 connector on the oscilloscope. See Figure 2-3 on page 2-6.
3. Use a 50 Ω BNC cable to connect the Channel 1 Mkr 1 connector on the AWG5000 to the CH2 connector on the oscilloscope. See Figure 2-3 on page 2-6.
4. Use the 50 Ω BNC cable to connect the Channel 1 Mkr 2 connector on the AWG5000 to the CH3 connector on the oscilloscope. See Figure 2-3 on page 2-6.

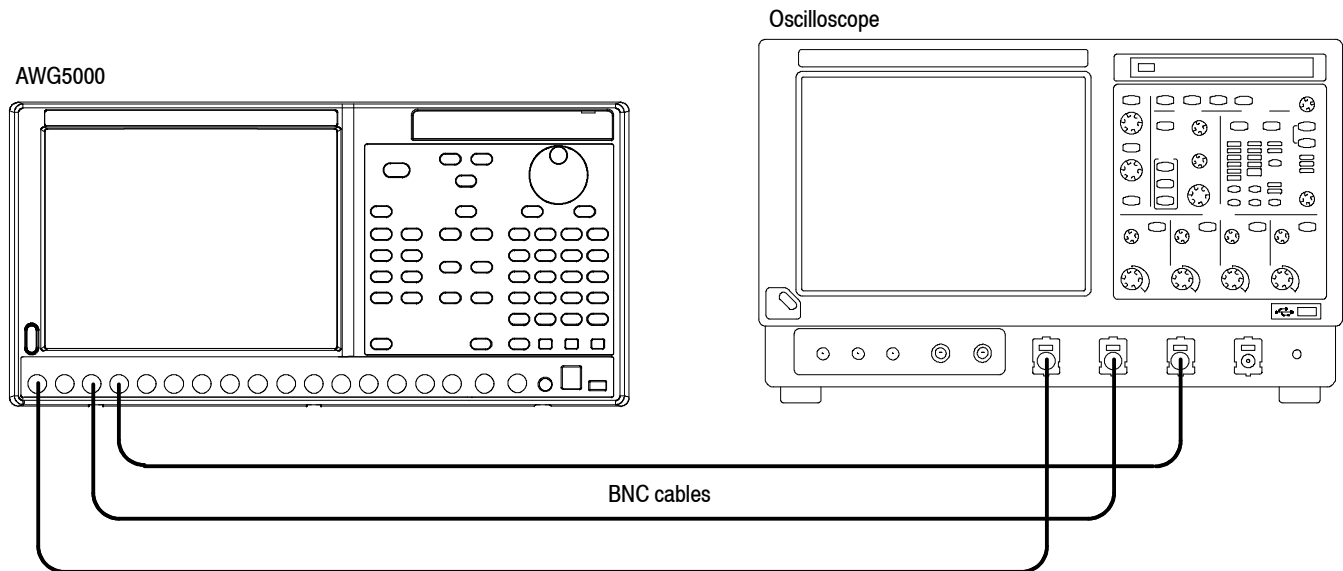

Figure 2-3: Equipment connections for checking the analog and marker outputs

5. Set the oscilloscope as indicated below:

Vertical scale 1 V/div (CH1, CH2, and CH3)
 Horizontal scale 200 ns/div
 Input coupling DC
 Input impedance 50 Ω
 CH 1 position +2 div (if necessary)
 CH 2 position -1 div (if necessary)
 CH 3 position -3 div (if necessary)
 Trigger source CH1
 Trigger level 0 mV
 Trigger slope Positive
 Trigger mode Auto

6. Press the **Factory Default** button on the AWG5000.
7. Press the **Ch1 Select** button on the AWG5000.
8. On the AWG5000, load the **sine_mk1_mk2** waveform as an output waveform.
 - a. Press the **File Open** button or select **File > Open File** to open the Open dialog box.
 - b. In the dialog box, navigate to the **C:\Program Files\Tektronix\AWG\System\PV** directory, and then select the **pv_AWG5000.awg** file. The **Waveform List** window appears.

NOTE. If your instrument is an AWG5002 or AWG5004, a warning message is displayed when you open the `pv_AWG5000.awg` file. Press the OK button.

- c. In the window, select (drag and drop) the **sine_mk1_mk2** waveform on the **User Defined** tab.
9. Press the **Ch 1 On** button on the AWG5000 to enable the channel 1 output.
10. Press the **Run** button on the AWG5000 to output the waveform.
11. Check that the Channel 1 Analog, Mkr 1, and Mkr 2 waveforms are properly displayed on the oscilloscope screen as shown in Figure 2-4.

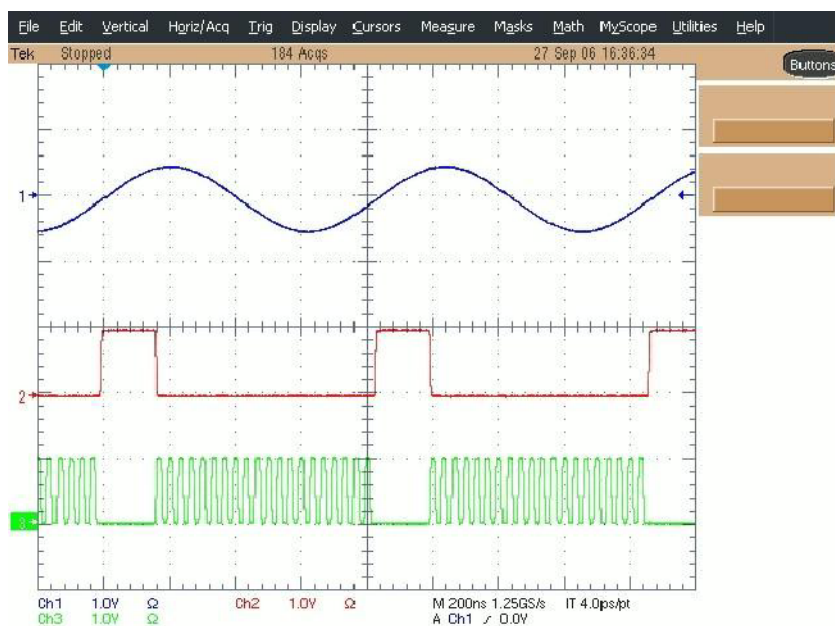

Figure 2-4: Output waveform from the Analog, Mkr1, and Mkr 2 connectors

12. Press the **Ch 1 On** button again to disable the channel 1 output.
13. Repeat the test for the Channel 2 Analog, Mkr 1, and Mkr 2 outputs.
14. *For the AWG5014 or AWG5004:* Repeat the test for the Channel 3 and Channel 4 Analog, Mkr 1, and Mkr 2 outputs.

Checking the Digital Data Outputs (Option 03 Only)

Equipment required	Oscilloscope (TDS5054B or equivalent) 50 Ω BNC cable 50 Ω SMB-BNC cable (Tektronix part number 174-5104-00)
Prerequisites	None

1. Press the **All Outputs On/Off** button on the AWG5000 to turn off all the outputs.
2. Use the 50 Ω SMB-BNC cable and 50 Ω BNC cable to connect the Ch 1 Digital Data Out 0 connector on the AWG5000 rear panel to the CH1 connector on the oscilloscope. See Figure 2-5.

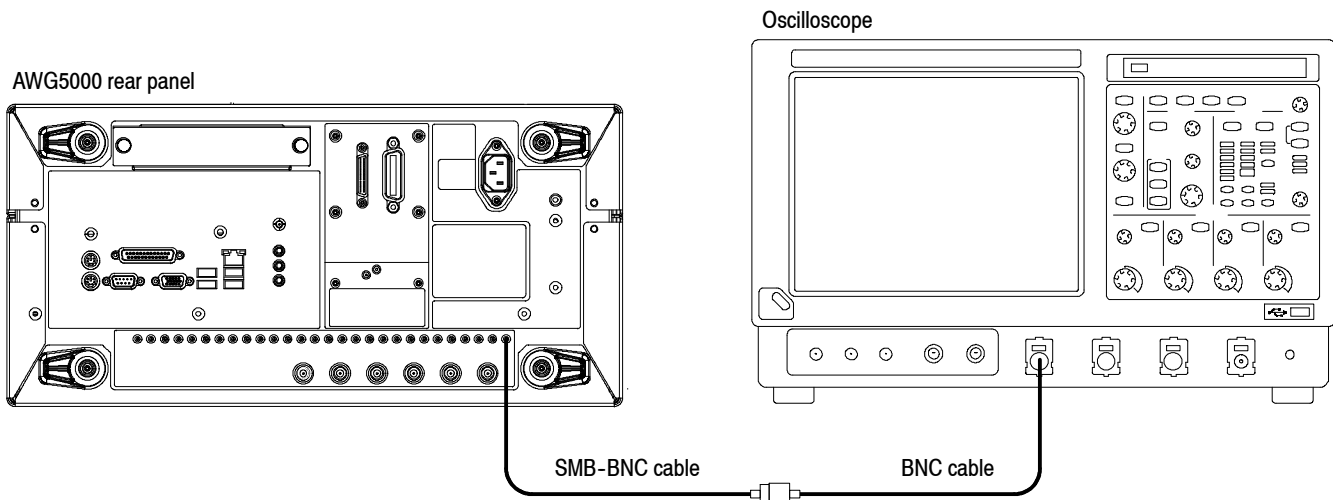

Figure 2-5: Equipment connection for checking the digital data outputs

3. Set the oscilloscope as indicated below:

Vertical scale 500 mV/div
Horizontal scale 200 ns/div
Input coupling DC
Input impedance 50 Ω
Trigger source CH1
Trigger level 500 mV
Trigger slope Positive
Trigger mode Auto

4. Press the **Factory Default** button on the AWG5000.
5. Press the **Ch1 Select** button on the AWG5000.
6. On the AWG5000, load the **square1** waveform as an output waveform.
 - a. Press the **File Open** button or select **File > Open File** to open the Open dialog box.
 - b. In the dialog box, navigate to the **C:\Program Files\Tektronix\AWG\System\PV** directory, and then select the **pv_AWG5000.awg** file. The **Waveform List** window appears.
 - c. In the window, select (drag and drop) the **square1** waveform on the **User Defined** tab.
7. Press the **Ch 1 On** button on the AWG5000 to enable the channel 1 output.
8. Press the **Run** button on the AWG5000 to output the waveform.

9. Check that the square wave is properly displayed on the oscilloscope screen as shown in Figure 2-6.

NOTE. If your instrument has firmware version 2.0 or earlier, the amplitude of the displayed waveform is different from the waveform shown in Figure 2-6.

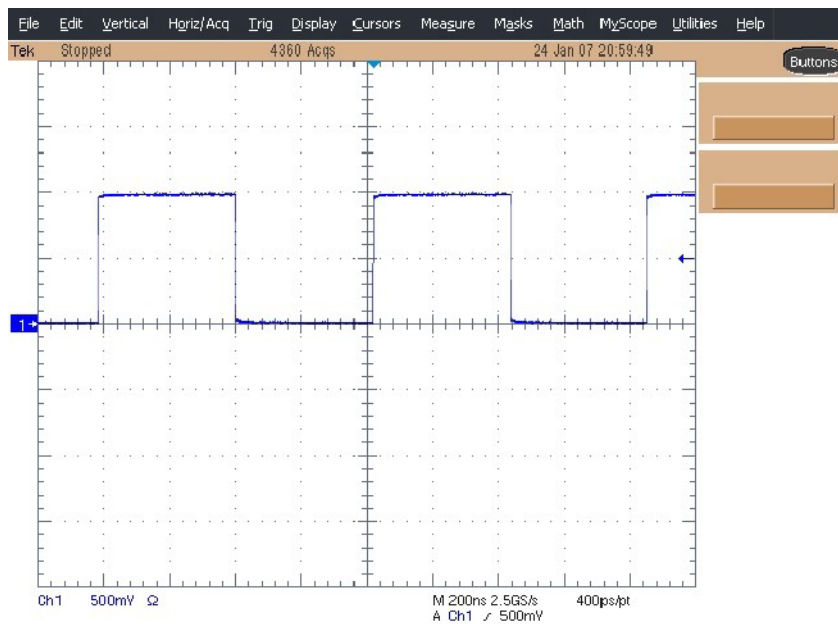

Figure 2-6: Output waveform from the Digital Data Out connector

10. Move the SMB-BNC cable from the Ch 1 Digital Data Out 0 connector to the Ch 1 Digital Data Out 1 connector and repeat step 9.
11. Repeat step 10 for the remaining digital data outputs (Ch 1 Digital Data Out 2 to Ch 1 Digital Data Out 13).
12. Press the **Ch 1 On** button again to disable the channel 1 output.
13. Repeat the test for all the Ch 2 Digital Data outputs.

Performance Tests

This section contains performance verification procedures for the specifications marked with the ✓ symbol.

Prerequisites

The tests in this section comprise an extensive, valid confirmation of performance and functionality when the following requirements are met:

- The cabinet must be installed on the instrument.
- You must have performed and passed the procedure *Diagnostics* and *Self Calibration* beginning on page 2-3, and the procedure *Functional Tests* beginning on page 2-5.
- The instrument must have been last adjusted at an ambient temperature between +20 °C and +30 °C, must have been operating for a warm-up period of at least 20 minutes, and must be operating at an ambient temperatures between +10 °C and +40 °C.

Equipment Required

Table 2-1 lists the test equipment required to perform all of the performance verification procedure. The table identifies examples of recommended equipment and lists the required precision where applicable. If you substitute other test equipment for the listed examples, the equipment must meet or exceed the listed tolerances.

Table 2-1: Equipment required

Item	Qty.	Minimum requirements	Recommended equipment
Frequency counter	1 ea.	Frequency accuracy: within ± 0.01 ppm	Agilent Technologies 53181A
Sampling oscilloscope	1 ea.	Bandwidth: 20 GHz or higher 2 channels	Tektronix CSA8200 with 80E03
Spectrum analyzer	1 ea.	Bandwidth: DC to 8 GHz	Tektronix RSA3308A
Digital multimeter	1 ea.	DC accuracy: within $\pm 0.01\%$	Keithley 2000 DMM
50 Ω BNC cable	2 ea.	DC to 2 GHz	Tektronix part number 012-0057-01
50 Ω BNC terminator	1 ea.	DC to 1 GHz, feedthrough	Tektronix part number 011-0049-02
BNC-SMA adaptor	2 ea.	BNC female to SMA male connectors	Tektronix part number 015-0554-00
BNC-N adaptor	1 ea.	BNC female to N male connectors	Tektronix part number 103-0045-00

Table 2-1: Equipment required (Cont.)

Item	Qty.	Minimum requirements	Recommended equipment
BNC-dual banana adaptor	1 ea.	BNC to dual banana plugs	Tektronix part number 103-0090-00
DC output lead set	1 ea.	8-pin twisted pair, 24 inch	Tektronix part number 012-1697-00 (supplied with the AWG5000)

Test Waveforms

Table 2-2 lists the test waveforms that are used for the performance verification procedures and functional test. These are included in the pv_AWG5000.awg file on the C: drive.

Table 2-2: Test waveforms

No.	Waveform name	Purpose
1	dc_minus	For checking the analog amplitude accuracy
2	dc_plus	For checking the analog amplitude accuracy
3	dc_zero	For checking the analog offset accuracy
4	marker_hi	For checking the marker high level accuracy
5	marker_low	For checking the marker low level accuracy
6	sine32	For checking analog harmonic distortion, analog non-harmonic spurious signal, and analog phase noise
7	sine_mk1_mk2	For the functional test (refer to page 2-5)
8	square1	For checking the marker output delay accuracy test

NOTE. If your instrument is an AWG5002 or AWG5004, a warning message is displayed when you open the pv_AWG5000.awg file. Press the OK button.

Test Record

Photocopy this page and the next eight pages, and use them to record the performance test results for your instrument.

AWG5000 Series Performance Test Record

Instrument Model: AWG5012 AWG5014 AWG5002 AWG5004
 Instrument Serial Number: _____ Certificate Number: _____
 Temperature: _____ RH %: _____
 Date of Calibration: _____ Technician: _____

Performance Test			Minimum	Incoming	Outgoing	Maximum
<i>10 MHz Reference Frequency Accuracy</i>			9.99998 MHz			10.00002 MHz
<i>Analog Offset Accuracy</i>						
Ch 1	Offset	Output mode				
	+2.25 V	Direct D/A out: Off	2190 mV			2310 mV
	+1 V	Direct D/A out: Off	965 mV			1035 mV
	0.0 V	Direct D/A out: Off	-15 mV			+15 mV
	-1 V	Direct D/A out: Off	-1035 mV			-965 mV
	-2.25 V	Direct D/A out: Off	-2310 mV			-2190 mV
	N/A (0V)	Direct D/A out: On	-15 mV			+15 mV
	Ch 1	Offset	Output mode			
+2.25 V		Direct D/A out: Off	2190 mV			2310 mV
+1 V		Direct D/A out: Off	965 mV			1035 mV
0.0 V		Direct D/A out: Off	-15 mV			+15 mV
-1 V		Direct D/A out: Off	-1035 mV			-965 mV
-2.25 V		Direct D/A out: Off	-2310 mV			-2190 mV
N/A (0V)		Direct D/A out: On	-15 mV			+15 mV
Ch 2		Offset	Output mode			
	+2.25 V	Direct D/A out: Off	2190 mV			2310 mV
	+1 V	Direct D/A out: Off	965 mV			1035 mV
	0.0 V	Direct D/A out: Off	-15 mV			+15 mV
	-1 V	Direct D/A out: Off	-1035 mV			-965 mV
	-2.25 V	Direct D/A out: Off	-2310 mV			-2190 mV
	N/A (0V)	Direct D/A out: On	-15 mV			+15 mV

AWG5000 Series Performance Test Record (Cont.)

Performance Test			Minimum	Incoming	Outgoing	Maximum
Ch 2	Offset	Output mode				
	+2.25 V	Direct D/A out: Off	2190 mV			2310 mV
	+1 V	Direct D/A out: Off	965 mV			1035 mV
	0.0 V	Direct D/A out: Off	-15 mV			+15 mV
	-1 V	Direct D/A out: Off	-1035 mV			-965 mV
	-2.25 V	Direct D/A out: Off	-2310 mV			-2190 mV
	N/A (0V)	Direct D/A out: On	-15 mV			+15 mV
Ch 3	Offset	Output mode				
	+2.25 V	Direct D/A out: Off	2190 mV			2310 mV
	+1 V	Direct D/A out: Off	965 mV			1035 mV
	0.0 V	Direct D/A out: Off	-15 mV			+15 mV
	-1 V	Direct D/A out: Off	-1035 mV			-965 mV
	-2.25 V	Direct D/A out: Off	-2310 mV			-2190 mV
	N/A (0V)	Direct D/A out: On	-15 mV			+15 mV
Ch 3	Offset	Output mode				
	+2.25 V	Direct D/A out: Off	2190 mV			2310 mV
	+1 V	Direct D/A out: Off	965 mV			1035 mV
	0.0 V	Direct D/A out: Off	-15 mV			+15 mV
	-1 V	Direct D/A out: Off	-1035 mV			-965 mV
	-2.25 V	Direct D/A out: Off	-2310 mV			-2190 mV
	N/A (0V)	Direct D/A out: On	-15 mV			+15 mV
Ch 4	Offset	Output mode				
	+2.25 V	Direct D/A out: Off	2190 mV			2310 mV
	+1 V	Direct D/A out: Off	965 mV			1035 mV
	0.0 V	Direct D/A out: Off	-15 mV			+15 mV
	-1 V	Direct D/A out: Off	-1035 mV			-965 mV
	-2.25 V	Direct D/A out: Off	-2310 mV			-2190 mV
	N/A (0V)	Direct D/A out: On	-15 mV			+15 mV
Ch 4	Offset	Output mode				
	+2.25 V	Direct D/A out: Off	2190 mV			2310 mV
	+1 V	Direct D/A out: Off	965 mV			1035 mV
	0.0 V	Direct D/A out: Off	-15 mV			+15 mV
	-1 V	Direct D/A out: Off	-1035 mV			-965 mV
	-2.25 V	Direct D/A out: Off	-2310 mV			-2190 mV
	N/A (0V)	Direct D/A out: On	-15 mV			+15 mV

AWG5000 Series Performance Test Record (Cont.)

Performance Test		Minimum	Incoming	Outgoing	Maximum
<i>Analog Amplitude Accuracy</i>					
Ch1	Amplitude	Output mode			
	20 mVp-p	Direct D/A out: Off	17.6 mV		22.4 mV
	200 mVp-p	Direct D/A out: Off	194 mV		206 mV
	500 mVp-p	Direct D/A out: Off	488 mV		512 mV
	1.0 Vp-p	Direct D/A/out: Off	0.978 V		1.022 V
	2.0 Vp-p	Direct D/A/out: Off	1.958 V		2.042 V
	4.5 Vp-p	Direct D/A/out: Off	4.408 V		4.592 V
	20 mVp-p	Direct D/A out: On	17.6 mV		22.4 mV
	200 mVp-p	Direct D/A out: On	194 mV		206 mV
	600 mVp-p	Direct D/A out: On	586 mV		614 mV
Ch1	Amplitude	Output mode			
	20 mVp-p	Direct D/A out: Off	17.6 mV		22.4 mV
	200 mVp-p	Direct D/A out: Off	194 mV		206 mV
	500 mVp-p	Direct D/A out: Off	488 mV		512 mV
	1.0 Vp-p	Direct D/A/out: Off	0.978 V		1.022 V
	2.0 Vp-p	Direct D/A/out: Off	1.958 V		2.042 V
	4.5 Vp-p	Direct D/A/out: Off	4.408 V		4.592 V
	20 mVp-p	Direct D/A out: On	17.6 mV		22.4 mV
	200 mVp-p	Direct D/A out: On	194 mV		206 mV
	600 mVp-p	Direct D/A out: On	586 mV		614 mV
Ch2	Amplitude	Output mode			
	20 mVp-p	Direct D/A out: Off	17.6 mV		22.4 mV
	200 mVp-p	Direct D/A out: Off	194 mV		206 mV
	500 mVp-p	Direct D/A out: Off	488 mV		512 mV
	1.0 Vp-p	Direct D/A/out: Off	0.978 V		1.022 V
	2.0 Vp-p	Direct D/A/out: Off	1.958 V		2.042 V
	4.5 Vp-p	Direct D/A/out: Off	4.408 V		4.592 V
	20 mVp-p	Direct D/A out: On	17.6 mV		22.4 mV
	200 mVp-p	Direct D/A out: On	194 mV		206 mV
	600 mVp-p	Direct D/A out: On	586 mV		614 mV

AWG5000 Series Performance Test Record (Cont.)

Performance Test			Minimum	Incoming	Outgoing	Maximum
Ch2	Amplitude	Output mode				
	20 mVp-p	Direct D/A out: Off	17.6 mV			22.4 mV
	200 mVp-p	Direct D/A out: Off	194 mV			206 mV
	500 mVp-p	Direct D/A out: Off	488 mV			512 mV
	1.0 Vp-p	Direct D/A/out: Off	0.978 V			1.022 V
	2.0 Vp-p	Direct D/A/out: Off	1.958 V			2.042 V
	4.5 Vp-p	Direct D/A/out: Off	4.408 V			4.592 V
	20 mVp-p	Direct D/A out: On	17.6 mV			22.4 mV
	200 mVp-p	Direct D/A out: On	194 mV			206 mV
	600 mVp-p	Direct D/A out: On	586 mV			614 mV
	Ch3	Amplitude	Output mode			
20 mVp-p		Direct D/A out: Off	17.6 mV			22.4 mV
200 mVp-p		Direct D/A out: Off	194 mV			206 mV
500 mVp-p		Direct D/A out: Off	488 mV			512 mV
1.0 Vp-p		Direct D/A/out: Off	0.978 V			1.022 V
2.0 Vp-p		Direct D/A/out: Off	1.958 V			2.042 V
4.5 Vp-p		Direct D/A/out: Off	4.408 V			4.592 V
20 mVp-p		Direct D/A out: On	17.6 mV			22.4 mV
200 mVp-p		Direct D/A out: On	194 mV			206 mV
600 mVp-p		Direct D/A out: On	586 mV			614 mV
Ch3		Amplitude	Output mode			
	20 mVp-p	Direct D/A out: Off	17.6 mV			22.4 mV
	200 mVp-p	Direct D/A out: Off	194 mV			206 mV
	500 mVp-p	Direct D/A out: Off	488 mV			512 mV
	1.0 Vp-p	Direct D/A/out: Off	0.978 V			1.022 V
	2.0 Vp-p	Direct D/A/out: Off	1.958 V			2.042 V
	4.5 Vp-p	Direct D/A/out: Off	4.408 V			4.592 V
	20 mVp-p	Direct D/A out: On	17.6 mV			22.4 mV
	200 mVp-p	Direct D/A out: On	194 mV			206 mV
	600 mVp-p	Direct D/A out: On	586 mV			614 mV

AWG5000 Series Performance Test Record (Cont.)

Performance Test			Minimum	Incoming	Outgoing	Maximum
Ch4	Amplitude	Output mode				
	20 mVp-p	Direct D/A out: Off	17.6 mV			22.4 mV
	200 mVp-p	Direct D/A out: Off	194 mV			206 mV
	500 mVp-p	Direct D/A out: Off	488 mV			512 mV
	1.0 Vp-p	Direct D/A/out: Off	0.978 V			1.022 V
	2.0 Vp-p	Direct D/A/out: Off	1.958 V			2.042 V
	4.5 Vp-p	Direct D/A/out: Off	4.408 V			4.592 V
	20 mVp-p	Direct D/A out: On	17.6 mV			22.4 mV
	200 mVp-p	Direct D/A out: On	194 mV			206 mV
	600 mVp-p	Direct D/A out: On	586 mV			614 mV
Ch4	Amplitude	Output mode				
	20 mVp-p	Direct D/A out: Off	17.6 mV			22.4 mV
	200 mVp-p	Direct D/A out: Off	194 mV			206 mV
	500 mVp-p	Direct D/A out: Off	488 mV			512 mV
	1.0 Vp-p	Direct D/A/out: Off	0.978 V			1.022 V
	2.0 Vp-p	Direct D/A/out: Off	1.958 V			2.042 V
	4.5 Vp-p	Direct D/A/out: Off	4.408 V			4.592 V
	20 mVp-p	Direct D/A out: On	17.6 mV			22.4 mV
	200 mVp-p	Direct D/A out: On	194 mV			206 mV
	600 mVp-p	Direct D/A out: On	586 mV			614 mV
<i>Analog Harmonic Distortion (AWG501x)</i>						
Ch 1	Amplitude	Output mode				
	2.0 V	Direct D/A out: Off	none			-40 dBc
	0.6 V	Direct D/A out: On	none			-49 dBc
Ch 2	Amplitude	Output mode				
	2.0 V	Direct D/A out: Off	none			-40 dBc
	0.6 V	Direct D/A out: On	none			-49 dBc
Ch 3	Amplitude	Output mode				
	2.0 V	Direct D/A out: Off	none			-40 dBc
	0.6 V	Direct D/A out: On	none			-49 dBc
Ch 4	Amplitude	Output mode				
	2.0 V	Direct D/A out: Off	none			-40 dBc
	0.6 V	Direct D/A out: On	none			-49 dBc

AWG5000 Series Performance Test Record (Cont.)

Performance Test			Minimum	Incoming	Outgoing	Maximum
<i>Analog Harmonic Distortion (AWG500x)</i>						
Ch 1	Amplitude	Output mode				
	2.0 V	Direct D/A out: Off	none			-46 dBc
	0.6 V	Direct D/A out: On	none			-55 dBc
Ch 2	Amplitude	Output mode				
	2.0 V	Direct D/A out: Off	none			-46 dBc
	0.6 V	Direct D/A out: On	none			-55 dBc
Ch 3	Amplitude	Output mode				
	2.0 V	Direct D/A out: Off	none			-46 dBc
	0.6 V	Direct D/A out: On	none			-55 dBc
Ch 4	Amplitude	Output mode				
	2.0 V	Direct D/A out: Off	none			-46 dBc
	0.6 V	Direct D/A out: On	none			-55 dBc
<i>Analog Non-Harmonic Spurious</i>						
Ch1	Amplitude	Output mode				
	2.0 V	Direct D/A out: Off	none			-60 dBc
Ch 2	Amplitude	Output mode				
	2.0 V	Direct D/A out: Off	none			-60 dBc
Ch 3	Amplitude	Output mode				
	2.0 V	Direct D/A out: Off	none			-60 dBc
Ch 4	Amplitude	Output mode				
	2.0 V	Direct D/A out: Off	none			-60 dBc
<i>Analog Phase Noise (at 10 kHz offset)</i>						
Ch 1	Amplitude	Output mode				
	2.0 V	Direct D/A out: Off	none			-85 dBc/Hz
Ch 2	Amplitude	Output mode				
	2.0 V	Direct D/A out: Off	none			-85 dBc/Hz
Ch 3	Amplitude	Output mode				
	2.0 V	Direct D/A out: Off	none			-85 dBc/Hz
Ch 4	Amplitude	Output mode				
	2.0 V	Direct D/A out: Off	none			-85 dBc/Hz

AWG5000 Series Performance Test Record (Cont.)

Performance Test			Minimum	Incoming	Outgoing	Maximum
<i>Marker High and Low Level Accuracy</i>						
Ch 1	Mkr 1	High level setting				
		+2.7 V	2.31 V			3.09 V
		+1.0 V	780 mV			1220 mV
		0.0 V	-120 mV			+120 mV
		-0.9 V	-1.11 V			-0.69 V
		Low level setting				
		+2.6 V	2.22 V			2.98 V
		+1.0 V	780 mV			1220 mV
		0.0 V	-120 mV			+120 mV
		-1.0 V	-1220 mV			-780 mV
	Mkr 2	High level setting				
		+2.7 V	2.31 V			3.09 V
		+1.0 V	780 mV			1220 mV
		0.0 V	-120 mV			+120 mV
		-0.9 V	-1.11 V			-0.69 V
		Low level setting				
		+2.6 V	2.22 V			2.98 V
		+1.0 V	780 mV			1220 mV
		0.0 V	-120 mV			+120 mV
		-1.0 V	-1220 mV			-780 mV
Ch 2	Mkr 1	High level setting				
		+2.7 V	2.31 V			3.09 V
		+1.0 V	780 mV			1220 mV
		0.0 V	-120 mV			+120 mV
		-0.9 V	-1.11 V			-0.69 V
		Low level setting				
		+2.6 V	2.22 V			2.98 V
		+1.0 V	780 mV			1220 mV
		0.0 V	-120 mV			+120 mV
		-1.0 V	-1220 mV			-780 mV

AWG5000 Series Performance Test Record (Cont.)

Performance Test		Minimum	Incoming	Outgoing	Maximum
Mkr 2	High level setting				
	+2.7 V	2.31 V			3.09 V
	+1.0 V	780 mV			1220 mV
	0.0 V	-120 mV			+120 mV
	-0.9 V	-1.11 V			-0.69 V
	Low level setting				
	+2.6 V	2.22 V			2.98 V
	+1.0 V	780 mV			1220 mV
	0.0 V	-120 mV			+120 mV
	-1.0 V	-1220 mV			-780 mV
Ch 3 Mkr 1	High level setting				
	+2.7 V	2.31 V			3.09 V
	+1.0 V	780 mV			1220 mV
	0.0 V	-120 mV			+120 mV
	-0.9 V	-1.11 V			-0.69 V
	Low level setting				
	+2.6 V	2.22 V			2.98 V
	+1.0 V	780 mV			1220 mV
	0.0 V	-120 mV			+120 mV
	-1.0 V	-1220 mV			-780 mV
Mkr 2	High level setting				
	+2.7 V	2.31 V			3.09 V
	+1.0 V	780 mV			1220 mV
	0.0 V	-120 mV			+120 mV
	-0.9 V	-1.11 V			-0.69 V
	Low level setting				
	+2.6 V	2.22 V			2.98 V
	+1.0 V	780 mV			1220 mV
	0.0 V	-120 mV			+120 mV
	-1.0 V	-1220 mV			-780 mV
Ch 4 Mkr 1	High level setting				
	+2.7 V	2.31 V			3.09 V
	+1.0 V	780 mV			1220 mV
	0.0 V	-120 mV			+120 mV
	-0.9 V	-1.11 V			-0.69 V

AWG5000 Series Performance Test Record (Cont.)

Performance Test		Minimum	Incoming	Outgoing	Maximum	
Ch 4	Low level setting					
	+2.6 V	2.22 V			2.98 V	
	+1.0 V	780 mV			1220 mV	
	0.0 V	-120 mV			+120 mV	
	-1.0 V	-1220 mV			-780 mV	
	Mkr 2	High level setting				
		+2.7 V	2.31 V			3.09 V
		+1.0 V	780 mV			1220 mV
		0.0 V	-120 mV			+120 mV
		-0.9 V	-1.11 V			-0.69 V
Low level setting						
+2.6 V		2.22 V			2.98 V	
+1.0 V		780 mV			1220 mV	
0.0 V		-120 mV			+120 mV	
-1.0 V		-1220 mV			-780 mV	
<i>Marker Output Delay Accuracy</i>						
Ch 1	Mkr 1	700 ps			1300 ps	
	Mkr 2	700 ps			1300 ps	
Ch 2	Mkr 1	700 ps			1300 ps	
	Mkr 2	700 ps			1300 ps	
Ch 3	Mkr 1	700 ps			1300 ps	
	Mkr 2	700 ps			1300 ps	
Ch 4	Mkr 1	700 ps			1300 ps	
	Mkr 2	700 ps			1300 ps	
<i>DC Output Accuracy</i>						
DC output						
+5 V		4.77 V			5.23 V	
+3 V		2.83 V			3.17 V	
0.0 V		-80 mV			+80 mV	
-3 V		-3.17 V			-2.83 V	

10 MHz Reference Frequency Accuracy

Equipment required	Frequency counter 50 Ω BNC cable
Prerequisites	As listed under <i>Prerequisites</i> on page 2-11.

1. Use the 50 Ω BNC cable to connect the 10 MHz Reference Output connector on the AWG5000 to the frequency counter CH1 input. See Figure 2-7.

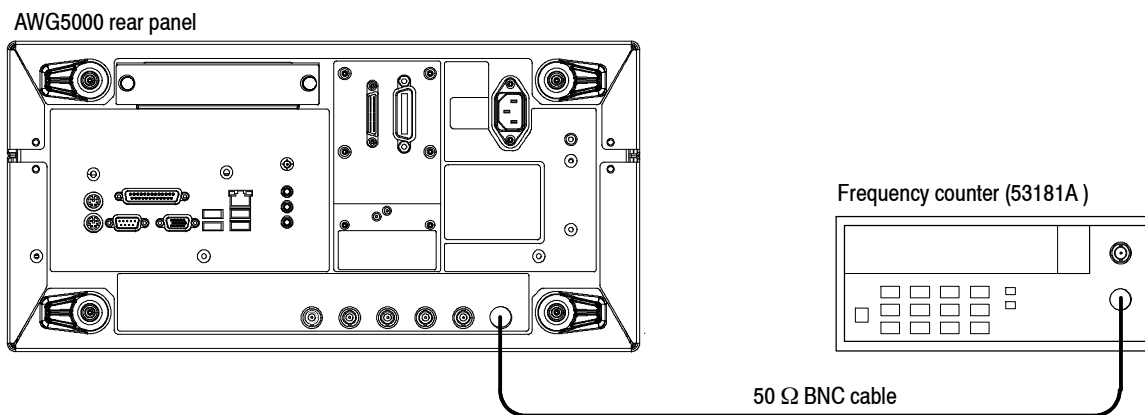

Figure 2-7: Equipment connection for verifying the 10 MHz reference frequency accuracy

2. Set the frequency counter as indicated below:

```

MEASURE ..... Frequency1
                Gate Time: 0.10 s
CHANNEL1 ..... Coupling: AC
                Impedance: 50  $\Omega$ 
    
```

3. Press the **Factory Default** button on the AWG5000.
4. Verify that the frequency counter reading falls within the range of 9.99998 MHz to 10.00002 MHz (± 2 ppm).
5. Disconnect the test setup.

Analog Offset Accuracy

Equipment required	Digital multimeter 50 Ω BNC cable 50 Ω BNC terminator BNC-dual banana adaptor
Prerequisites	As listed under <i>Prerequisites</i> on page 2-11.

Measuring the Terminator Resistance

Before verifying the analog offset accuracy, you need to measure the resistance of the 50 Ω BNC terminator.

1. Connect the BNC-dual banana adaptor and 50 Ω BNC terminator to the HI and LO inputs on the digital multimeter. See Figure 2-8.

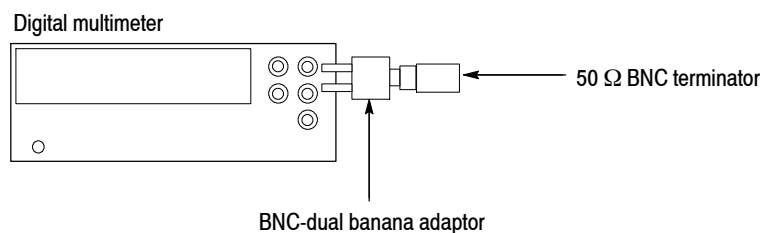

Figure 2-8: Equipment connection for measuring the terminator resistance

2. Set the digital multimeter to the **Ω 2 wires** mode.
3. Measure the resistance and note the value as **Term_R**.
4. Set the digital multimeter to the **VDC** mode.
5. Disconnect the test setup.

Verifying the Analog Offset Accuracy

1. Press the **All Outputs On/Off** button on the AWG5000 to turn off all the outputs.
2. Use the 50 Ω BNC cable, 50 Ω BNC terminator, and BNC-dual banana adaptor to connect the Channel 1 Analog connector on the AWG5000 to the HI and LO inputs on the digital multimeter. See Figure 2-9.

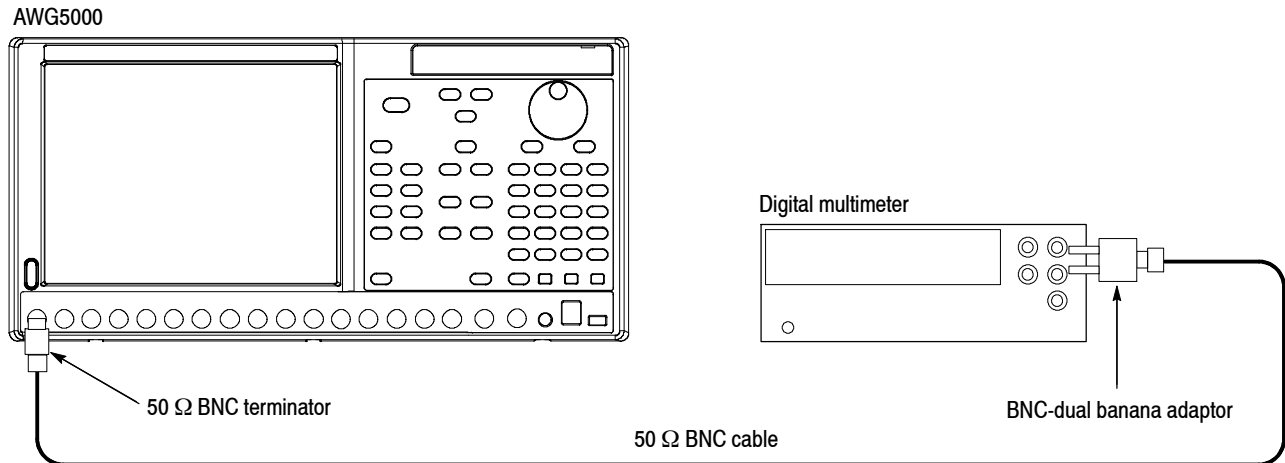

Figure 2-9: Equipment connection for verifying the analog offset accuracy

3. Press the **Factory Default** button on the AWG5000.
4. Press the **Ch1 Select** button on the AWG5000.
5. On the AWG5000, load the **dc_zero** waveform as an output waveform.
 - a. Press the **File Open** button or select **File > Open File** to open the Open dialog box.
 - b. In the dialog box, navigate to the **C:\Program Files\Tektronix\AWG\System\PV** directory, and then select the **pv_AWG5000.awg** file. The **Waveform List** window appears.
 - c. In the window, select (drag and drop) the **dc_zero** waveform on the **User Defined** tab.
6. Press the **Ch 1 On** button on the AWG5000 to enable the channel 1 output.
7. Press the **Run** button on the AWG5000 to output the waveform.

8. Set the offset of the AWG5000 to the level shown in the first row of Table 2-3.

Table 2-3: Analog offset accuracy

Offset settings	Output mode settings	Accuracy limits
+2.25 V	Direct D/A out: Off	2190 mV to 2310 mV
1 V	Direct D/A out: Off	965 mV to 1035 mV
0.0 V	Direct D/A out: Off	-15 mV to +15 mV
-1 V	Direct D/A out: Off	-1035 mV to -965 mV
-2.25 V	Direct D/A out: Off	-2310 mV to -2190 mV
N/A (0 V)	Direct D/A out: On	-15 mV to + 15 mV

9. Measure the output voltage on the digital multimeter and note the value as **Measured_voltage**.
10. Use the following formula to compensate the voltage for the 50 Ω BNC terminator:
- $$\text{Voltage} = [(\text{Term_R} + 50) / (2 \times \text{Term_R})] \times \text{Measured_voltage}$$
- Where Term_R is the resistance of the 50 Ω BNC terminator measured in step 3 of *Measuring the Terminator Resistance* on page 2-23.
11. Verify that the calculated value falls within the limits given in Table 2-3.
12. Repeat steps 8 through 11 for each offset setting in Table 2-3.
13. Move the BNC terminator from the Channel 1 Analog connector to the Channel 1 Analog connector.
14. Repeat steps 8 through 12.
15. Repeat steps 6 through 14 for the Channel 2 output.
16. *For the AWG5014 or AWG5004:* Repeat the test for the Channel 3 and Channel 4 outputs.
17. Press the **All Outputs On/Off** button on the AWG5000 to turn off all the outputs.
18. Disconnect the test setup.

Analog Amplitude Accuracy

Equipment required	Digital multimeter 50 Ω BNC cable 50 Ω BNC terminator BNC-dual banana adaptor
Prerequisites	As listed under <i>Prerequisites</i> on page 2-11.

1. Perform *Measuring the Terminator Resistance* on page 2-23.
2. Press the **All Outputs On/Off** button on the AWG5000 to turn off all the outputs.
3. Use the 50 Ω BNC cable, 50 Ω BNC terminator, and BNC-dual banana adaptor to connect the Channel 1 Analog connector on the AWG5000 to the HI and LO inputs on the digital multimeter. See Figure 2-9 on page 2-24.
4. Press the **Factory Default** button on the AWG5000.
5. Press the **Ch 1 Select** button on the AWG5000.
6. On the AWG5000, load the **dc_plus** waveform as an output waveform.
 - a. Press the **File Open** button or select **File > Open File** to open the Open dialog box.
 - b. In the dialog box, navigate to the **C:\Program Files\Tektronix\AWG\System\PV** directory, and then select the **pv_AWG5000.awg** file. The **Waveform List** window appears.
 - c. In the window, select (drag and drop) the **dc_plus** waveform on the **User Defined** tab.
7. Press the **Ch 1 On** button on the AWG5000 to enable the channel 1 output.
8. Press the **Run** button on the AWG5000 to output the waveform.
9. Set the amplitude and output mode of the AWG5000 as shown in the first row of Table 2-4.

Table 2-4: Analog amplitude accuracy

Amplitude settings	Output mode settings	Accuracy limits
20 mVp-p	Direct D/A out: Off	17.6 mV to 22.4 mV
200 mVp-p	Direct D/A out: Off	194 mV to 206 mV
500 mVp-p	Direct D/A out: Off	488 mV to 512 mV
1.0 Vp-p	Direct D/A out: Off	0.978 V to 1.022 V
2.0 Vp-p	Direct D/A out: Off	1.958 V to 2.042 V
4.5 Vp-p	Direct D/A out: Off	4.408 V to 4.592 V
20 mVp-p	Direct D/A out: On	17.6 mV to 22.4 mV
200 mVp-p	Direct D/A out: On	194 mV to 206 mV
600 mVp-p	Direct D/A out: On	586 mV to 614 mV

10. Measure the output voltage on the digital multimeter and note the value as **Measured_voltage_1**.
11. Use the following formula to compensate the voltage for the 50 Ω BNC terminator:

$$V_{\text{high}} = [(Term_R + 50) / (2 \times Term_R)] \times \text{Measured_voltage_1}$$
 Where Term_R is the resistance of the 50 Ω BNC terminator measured in step 3 on page 2-23.
12. In the **Waveform List** window, select the **dc_minus** waveform on the **User Defined** tab.
13. Measure the output voltage on the digital multimeter and note the value as **Measured_voltage_2**.
14. Use the following formula to compensate the voltage for the 50 Ω BNC terminator:

$$V_{\text{low}} = [(Term_R + 50) / (2 \times Term_R)] \times \text{Measured_voltage_2}$$
 Where Term_R is the resistance of the 50 Ω BNC terminator measured in step 3 on page 2-23.
15. Verify that the voltage difference $|(V_{\text{high}} - V_{\text{low}})|$ falls within the limits given in Table 2-4.
16. Repeat steps 9 through 15 for each amplitude setting in Table 2-4.
17. Move the BNC terminator from the Channel 1 Analog connector to the Channel 1 Analog connector.
18. Repeat steps 9 through 16.

19. Repeat steps 7 through 18 for the Channel 2 output.
20. *For the AWG5014 or AWG5004:* Repeat the test for the Channel 3 and Channel 4 outputs.
21. Press the **All Outputs On/Off** button on the AWG5000 to turn off all the outputs.
22. Disconnect the test setup.

Analog Harmonic Distortion

Equipment required	Spectrum analyzer
	50 Ω BNC cable
	BNC-N adaptor
Prerequisites	As listed under Prerequisites on page 2-11.

1. Press the **All Outputs On/Off** button on the AWG5000 to turn off all the outputs.
2. Use the 50 Ω BNC cable and BNC-N adaptor to connect the Channel 1 Analog connector on the AWG5000 to the INPUT connector on the spectrum analyzer. See Figure 2-10.

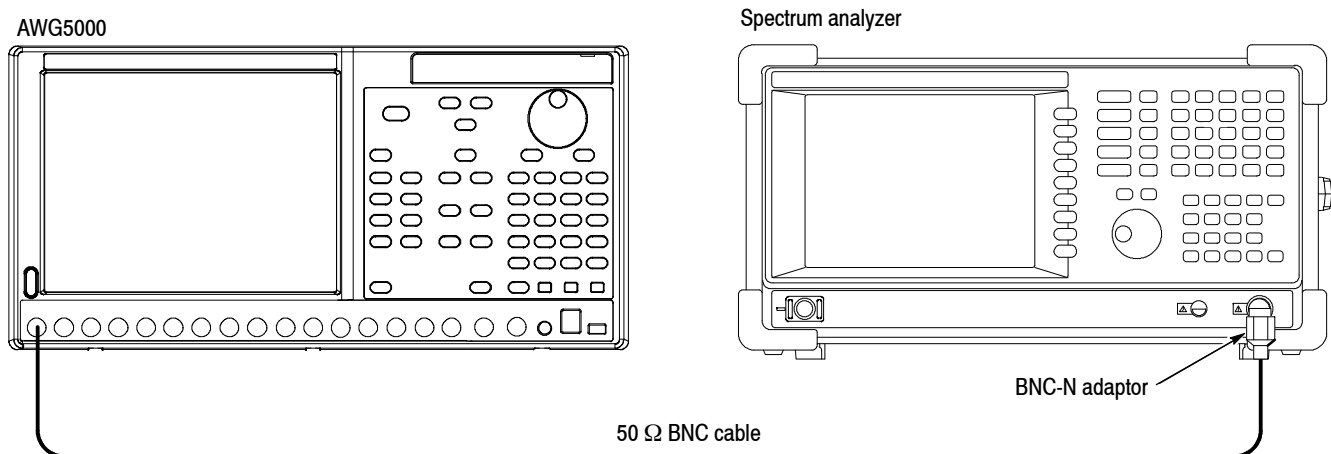

Figure 2-10: Equipment connections for verifying the analog harmonic distortion

3. Set the spectrum analyzer as indicated below:
 - Center frequency 100 MHz
 - Span 200 MHz
 - RBW 20 kHz
4. Press the **Factory Default** button on the AWG5000.
5. Press the **Ch 1 Select** button on the AWG5000.
6. On the AWG5000, load the **sine_32** waveform as an output waveform.
 - a. Press the **File Open** button or select **File > Open File** to open the Open dialog box.
 - b. In the dialog box, navigate to the **C:\Program Files\Tektronix\AWG\System\PV** directory, and then select the **pv_AWG5000.awg** file. The **Waveform List** window appears.
 - c. In the window, select (drag and drop) the **sine_32** waveform on the **User Defined** tab.
7. Press the **Ch 1 On** button on the AWG5000 to enable the channel 1 output.
8. Press the **Run** button on the AWG5000 to output the waveform.
9. Make the AWG5000 settings shown in the first row (or corresponding row for your instrument) of Table 2-5.

Table 2-5: Analog harmonic distortion

AWG5000 model and settings				Measurement frequency (MHz)				Accuracy Limit
Model	Output mode	Amplitude	Sampling rate (output frequency)	2nd	3rd	4th	5th	Nth reference
AWG501x	Direct D/A out: Off	2.0 Vp-p	1.2 GS/s (37.5 MHz)	75	112.5	150	187.5	-40 dBc
	Direct D/A out: On	0.6 Vp-p						-49 dBc
AWG500x	Direct D/A out: Off	2.0 Vp-p	600 MS/s (18.75 MHz)	37.5	56.25	75	93.75	-46 dBc
	Direct D/A out: On	0.6 Vp-p						-55 dBc

10. Use the delta measurement function of the spectrum analyzer to measure harmonic distortion of each measurement frequency.
11. Verify that the harmonic distortion falls within the limits given in Table 2-5.
12. Repeat steps 9 through 11 for each setting in Table 2-5.
13. Move the 50 Ω BNC cable from Channel 1 Analog connector to the Channel 2 Analog connector.

14. Repeat steps 7 through 12 for the Channel 2 output.
15. *For the AWG5014 or AWG5004:* Repeat the test for the Channel 3 and Channel 4 outputs.
16. Press the **All Outputs On/Off** button on the AWG5000 to turn off all the outputs.
17. Disconnect the test setup.

Analog Non-Harmonic Spurious Signal

Equipment required	Spectrum analyzer 50 Ω BNC cable BNC-N adaptor
Prerequisites	As listed under Prerequisites on page 2-11.

1. Press the **All Outputs On/Off** button on the AWG5000 to turn off all the outputs.
2. Use the 50 Ω BNC cable and BNC-N adaptor to connect the Channel 1 Analog connector on the AWG5000 to the INPUT connector on the spectrum analyzer. See Figure 2-11.

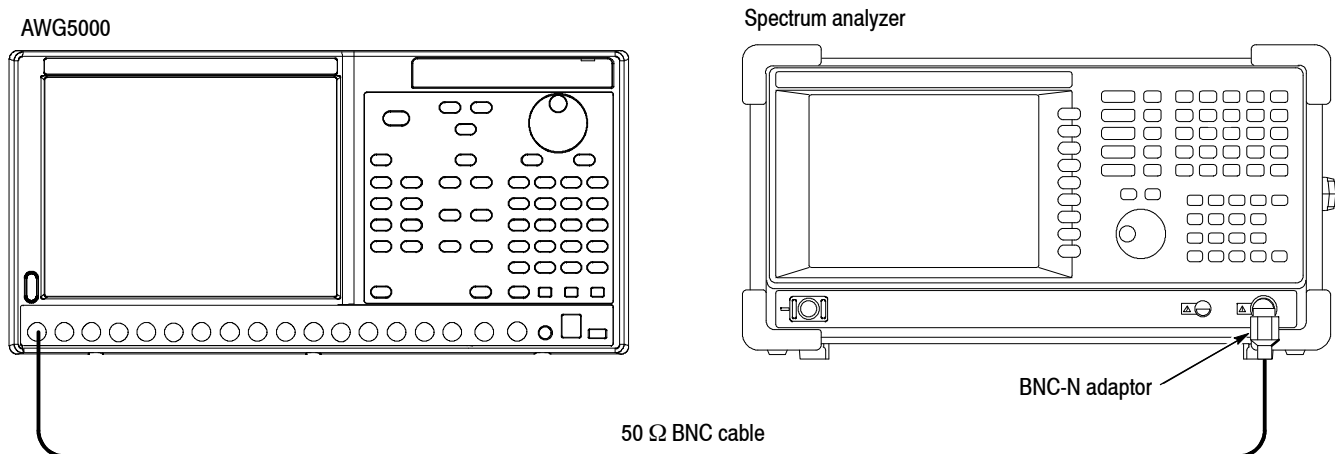

Figure 2-11: Equipment connections for verifying the non-harmonic spurious signal

3. Press the **Factory Default** button on the AWG5000.

4. Press the **Ch1 Select** button on the AWG5000.
5. On the AWG5000, load the **sine_32** waveform as an output waveform.
 - a. Press the **File Open** button or select **File > Open File** to open the Open dialog box.
 - b. In the dialog box, navigate to the **C:\Program Files\Tektronix\AWG\System\PV** directory, and then select the **pv_AWG5000.awg** file. The **Waveform List** window appears.
 - c. In the window, select (drag and drop) the **sine_32** waveform on the **User Defined** tab.
6. Press the **Ch 1 On** button on the AWG5000 to enable the channel 1 output.
7. Press the **Run** button on the AWG5000 to output the waveform.
8. Make the AWG5000 and spectrum analyzer settings shown in the first row or the second row of Table 2-6.

Table 2-6: Analog non-harmonic spurious signal

AWG5000 model and settings				Spectrum analyzer settings			Accuracy Limit
Model	Output mode	Amplitude	Sampling rate (output frequency)	Center frequency	Span	RBW	
AWG501x	Direct D/A out: Off	2.0 Vp-p	1.2 GS/s (37.5 MHz)	400 MHz	800 MHz	20 kHz	-60 dBc
AWG500x	Direct D/A out: Off	2.0 Vp-p	600 MS/s (18.75 MHz)	200 MHz	400 MHz	20 kHz	-60 dBc

9. Use the spectrum analyzer to measure non-harmonic spurious signal of the Analog output over a frequency range of DC to 600 MHz (for the AWG500x, DC to 300 MHz). For example, note the reference level of the fundamental waveform, and then measure each spurious.
10. Verify that the non-harmonic spurious signal falls within the limits given in Table 2-6.
11. Move the 50 Ω BNC cable from the Channel 1 Analog connector to the Channel 2 Analog connector.
12. Repeat steps 6 through 10 for the Channel 2 output.
13. *For the AWG5014 or AWG5004:* Repeat the test for the Channel 3 and Channel 4 outputs.
14. Press the **All Outputs On/Off** button on the AWG5000 to turn off all the outputs.
15. Disconnect the test setup.

Analog Phase Noise

Equipment required	Spectrum analyzer
	50 Ω BNC cable
	BNC-N adaptor
Prerequisites	As listed under <i>Prerequisites</i> on page 2-11.

1. Press the **All Outputs On/Off** button on the AWG5000 to turn off all the outputs.
2. Use the 50 Ω BNC cable and BNC-N adaptor to connect the Channel 1 Analog connector on the AWG5000 to the INPUT connector on the spectrum analyzer. See Figure 2-12.

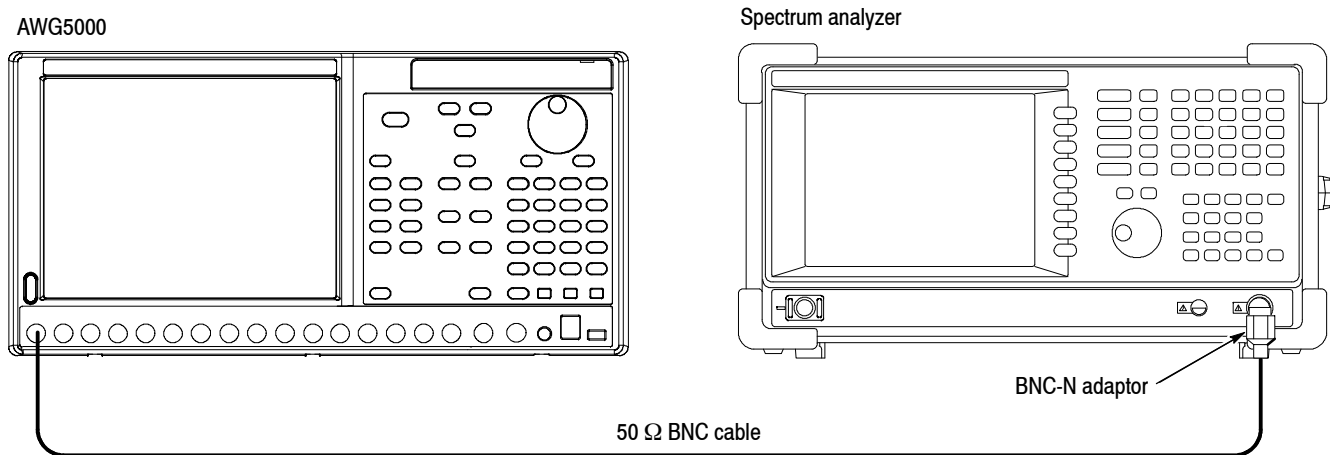

Figure 2-12: Equipment connections for verifying the analog phase noise

3. Press the **Factory Default** button on the AWG5000.
4. On the AWG5000, load the **sine_32** waveform as an output waveform.
 - a. Press the **File Open** button or select **File > Open File** to open the Open dialog box.
 - b. In the dialog box, navigate to the **C:\Program Files\Tektronix\AWG\System\PV** directory, and then select the **pv_AWG5000.awg** file. The **Waveform List** window appears.
 - c. In the window, select (drag and drop) the **sine_32** waveform on the **User Defined** tab.

5. Press the **Ch 1 On** button on the AWG5000 to enable the channel 1 output.
6. Press the **Run** button on the AWG5000 to output the waveform.
7. Make the AWG5000 and spectrum analyzer settings shown in the first row (or the second row for your instrument) of Table 2-7.
8. Use the spectrum analyzer to measure phase noise of the Analog output.
9. Verify that the analog phase noise at 10 kHz offset falls within the limits given in Table 2-7.

Table 2-7: Analog phase noise

AWG5000 model and settings				Spectrum analyzer settings			Accuracy Limit at 10 kHz offset
Model	Output mode	Amplitude	Sampling rate	Center frequency	Span	RBW	
AWG501x	Direct D/A out: Off	2.0 Vp-p	1.2 GS/s	37.5 MHz	50 kHz	100 Hz	-85 dBc/Hz
AWG500x	Direct D/A out: Off	2.0 Vp-p	600 MS/s	18.75 MHz	50 kHz	100 Hz	-85 dBc/Hz

10. Move the 50 Ω BNC cable from the Channel 1 Analog connector to the Channel 2 Analog connector.
11. Repeat steps 5 through 9 for the Channel 2 output.
12. *For the AWG5014 or AWG5004:* Repeat the test for the Channel 3 and Channel 4 outputs.
13. Press the **All Outputs On/Off** button on the AWG5000 to turn off all the outputs.
14. Disconnect the test setup.

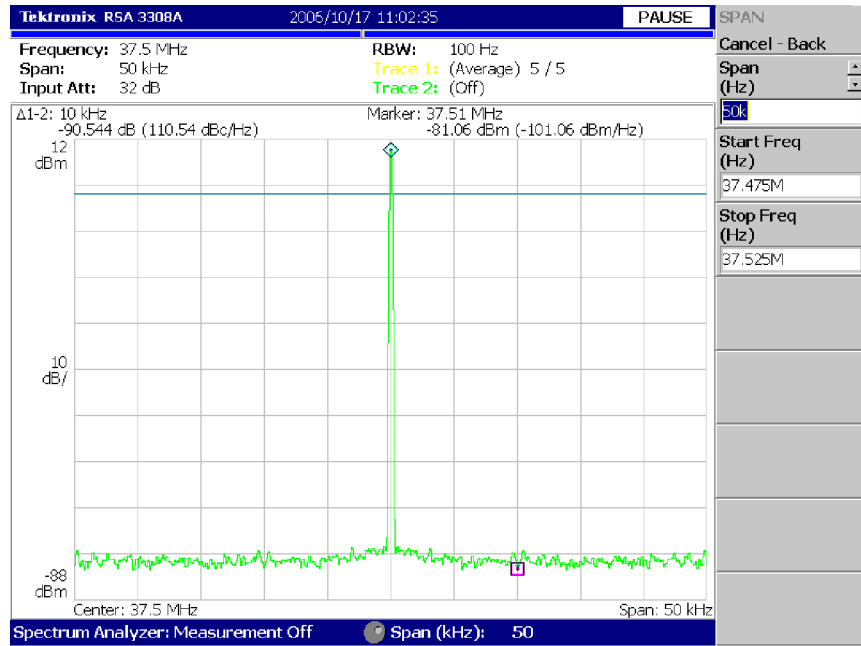

Figure 2-13: Example of the analog phase noise measurement

Marker High and Low Level Accuracy

Equipment required	Digital multimeter 50 Ω BNC cable 50 Ω BNC terminator BNC-dual banana adaptor
Prerequisites	As listed under <i>Prerequisites</i> on page 2-11.

1. Perform *Measuring the Terminator Resistance* on page 2-23.
2. Press the **All Outputs On/Off** button on the AWG5000 to turn off all the outputs.
3. Use the 50 Ω BNC cable, 50 Ω BNC terminator, and BNC-dual banana adaptor to connect the Channel 1 Mkr 1 connector on the AWG5000 to the HI and LO inputs on the digital multimeter. See Figure 2-14.

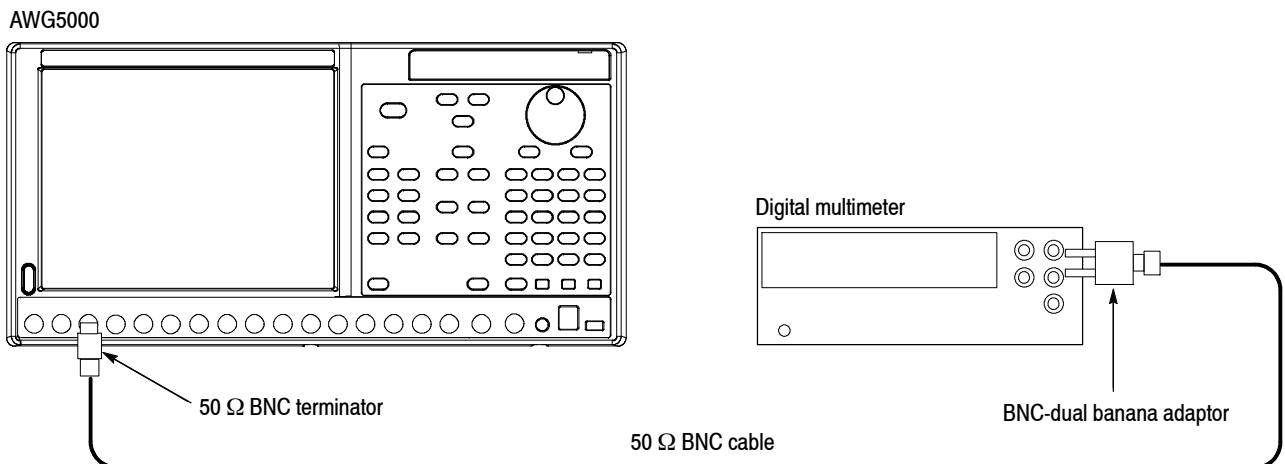

Figure 2-14: Equipment connection for verifying the marker high and low level accuracy

4. Press the **Factory Default** button on the AWG5000.
5. Press the **Ch1 Select** button on the AWG5000.
6. On the AWG5000, load the **marker_hi** waveform as an output waveform.
 - a. Press the **File Open** button or select **File > Open File** to open the Open dialog box.
 - b. In the dialog box, navigate to the **C:\Program Files\Tektronix\AWG\System\PV** directory, and then select the **pv_AWG5000.awg** file. The **Waveform List** window appears.
 - c. In the window, select the **marker_hi** waveform on the **User Defined** tab.
7. Press the **Ch 1 On** button on the AWG5000 to enable the channel 1 output.
8. Press the **Run** button on the AWG5000 to output the waveform.
9. Make the AWG5000 High Level setting shown in the first row of Table 2-8.

Table 2-8: Marker High and Low level accuracy

High level settings	Accuracy limits
+2.7 V	2.31 V to 3.09 V
+1.0 V	780 mV to 1220 mV
0.0 V	-120 mV to +120 mV
-0.9 V	-1.11 V to 0.69 V
Low level settings	Accuracy limits
+2.6 V	2.22 V to 2.98 V
+1.0 V	780 mV to 1220 mV
0.0 V	-120 mV to +120 mV
-1.0 V	-1220 mV to -780 mV

10. Measure the output voltage on the digital multimeter and note the value as **Measured_voltage_1**.
11. Use the following formula to compensate the voltage for the 50 Ω BNC terminator:

$$\text{Marker_High} = (\text{Term_R} + 50) / (2 \times \text{Term_R}) \times \text{Measured_voltage_1}$$

Where Term_R is the resistance of the 50 Ω BNC terminator measured in step 3 on page 2-23.

12. Verify that the marker High level falls within the limits given in Table 2-8.
13. Repeat steps 9 through 12 for each row in Table 2-8.
14. In the **Waveform List** window, select the **marker_low** waveform on the **User Defined** tab.
15. Press the **Ch 1 On** button on the AWG5000 to enable the channel 1 output.
16. Press the **Run** button on the AWG5000 to output the waveform.
17. Make the AWG5000 Low Level setting shown in the first row of Table 2-8 on page 2-36.
18. Measure the output voltage on the digital multimeter and note the value as **Measured_voltage_2**.
19. Use the following formula to compensate the voltage for the 50 Ω BNC terminator:
$$\text{Marker_Low} = (\text{Term_R} + 50) / (2 \times \text{Term_R}) \times \text{Measured_voltage_2}$$

Where Term_R is the resistance of the 50 Ω BNC terminator measured in step 3 on page 2-23.
20. Verify that the marker Low level falls within the limits given in Table 2-8 on page 2-36.
21. Repeat steps 17 through 20 for each row in Table 2-8 on page 2-36.
22. Press the **Ch 1 On** button to disable the channel 1 output.
23. Move the BNC terminator from the Channel 1 Mkr 1 connector to the Channel 1 Mkr 2 connector.
24. Repeat steps 7 through 21.
25. Move the 50 Ω BNC terminator from Channel 1 Mkr 2 connector to the Channel 2 Mkr 1 connector.
26. Repeat steps 7 through 24 for the Channel 2 marker outputs.
27. *For the AWG5014 or AWG5004:* Repeat the test for the Channel 3 and Channel 4 marker outputs.
28. Press the **All Outputs On/Off** button on the AWG5000 to turn off all the outputs.
29. Disconnect the test setup.

Marker Output Delay Accuracy

Equipment required	Sampling oscilloscope Two 50 Ω BNC cables Two BNC-SMA adaptors
Prerequisites	As listed under Prerequisites on page 2-11.

1. Press the **All Outputs On/Off** button on the AWG5000 to turn off all the outputs.
2. Use a 50 Ω BNC cable and BNC-SMA adaptor to connect the Channel 1 Mkr 1 connector on the AWG5000 to the CH1 connector on the sampling oscilloscope. See Figure 2-15.
3. Use the 50 Ω BNC cable and BNC-SMA adaptor to connect the Channel 1 Mkr 2 connector on the AWG5000 to the TRIGGER DIRECT connector on the sampling oscilloscope. See Figure 2-15.

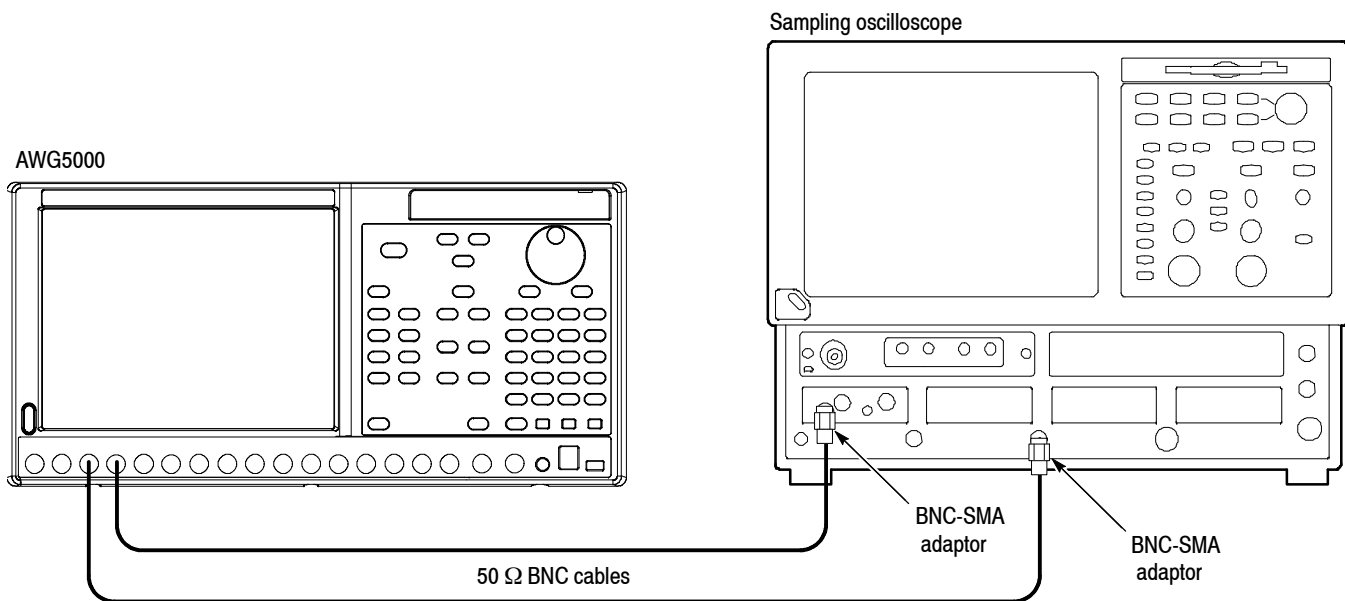

Figure 2-15: Equipment connections for verifying the marker output delay accuracy

4. Set the sampling oscilloscope as indicated below:
 - Vertical scale 250 mV/div
 - Horizontal scale 500 ps/div
 - Trigger source External Direct
 - Trigger level 150 mV (or Set to 50%)
 - Trigger slope positive
 - Measure Pulse measurement > Pulse Time > Delay
5. Press the **Factory Default** button on the AWG5000.
6. On the AWG5000, load the **square1** waveform as an output waveform.
 - a. Press the **File Open** button or select **File > Open File** to open the Open dialog box.
 - b. In the dialog box, navigate to the **C:\Program Files\Tektronix\AWG\System\PV** directory, and then select the **pv_AWG5000.awg** file. The **Waveform List** window appears.
 - c. In the window, select the **square1** waveform on the **User Defined** tab.
7. Press the **Ch 1 On** button on the AWG5000 to enable the channel 1 output.
8. Press the **Run** button on the AWG5000 to output the waveform.
9. On the oscilloscope, store the channel 1 waveform to **Ref 1** as a reference waveform.
10. On the AWG5000, set the **Marker 1** delay value to **1.00 ns**.
11. Use the oscilloscope to measure the delay time between the Ref 1 waveform and channel 1 waveform at the 50% level.
12. Verify that the delay time is within the range of 700 ps to 1300 ps.
13. Press the **Ch 1 On** button on the AWG5000 to disable the channel 1 output.
14. Move the 50 Ω BNC cable from the Channel 1 Mkr 1 connector to the Channel 1 Mkr 2 connector and from Channel 1 Mkr 2 connector to the Channel Mkr 1 connector.
15. Press the **Ch 1 On** button on the AWG5000 to enable the channel 1 output.
16. On the oscilloscope, store the channel 1 waveform to **Ref 1** as a reference waveform.
17. On the AWG5000, set the **Marker 2** delay value to **1.00 ns**.
18. Repeat steps 11 and 12.
19. Repeat steps 7 through 18 for the Channel 2 markers.

20. For the AWG5104 and AWG5004: Repeat the test for the Channel 3 and Channel 4 marker outputs.
21. Press the **All Outputs On/Off** button on the AWG5000 to turn off all the outputs.
22. Disconnect the test setup.

DC Output Voltage Accuracy

Equipment required	Digital multimeter DC output lead set Test leads (provided with the digital multimeter)
Prerequisites	As listed under <i>Prerequisites</i> on page 2-11.

1. Use the test leads to connect the HI and LO inputs on the digital multimeter. See Figure 2-16.
2. Use the DC output lead set to connect the DC Output connector on the AWG5000. See Figure 2-16.

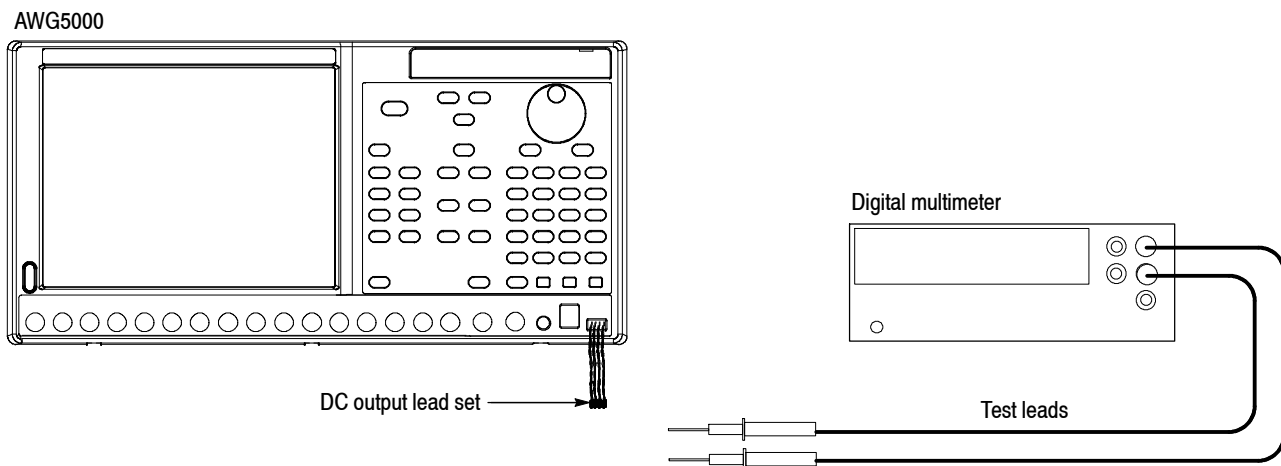

Figure 2-16: Equipment connection for verifying the DC output voltage accuracy

3. Set the digital multimeter to the **VDC** mode.
4. On the AWG5000, select the **DC Outputs** tab in the **Settings** window.

5. On the DC Output tab, set the DC 1, DC 2, DC 3, and DC 4 levels to the setting shown in the first row of Table 2-9.

Table 2-9: DC output voltage accuracy

DC output settings	Accuracy limits
+5 V	4.77 V to 5.23 V
+3 V	2.83 V to 3.17 V
0.0 V	-80 mV to +80 mV
-3 V	-3.17 V to -2.83 V

6. On the DC Outputs tab, select the **DC Output** check box to enable the DC output. The DC Output LED on the front panel lights.
7. Attach the black test lead to the connector lead from DC1 GND.
8. Attach the red test lead to the connector lead from DC1.
9. Verify that the DC output level falls within the limits given in Table 2-9.
10. Repeat steps 8 and 9 for DC 2, DC 3, and DC 4.
11. Repeat steps 5 through 10 for each row in Table 2-9.

This completes the AWG5000 performance verification.

